

C.A 6550

C.A 6555











Megohmmeters 10 kV and 15kV

Thank you for purchasing a **megohmmeter C.A 6550 or C.A 6555**.

For best results from your instrument:

- **read** these operating instructions carefully,
- **comply with** the precautions for use.

	WARNING, risk of DANGER! The operator must refer to these instructions whenever this danger symbol appears.
	Equipment protected by double insulation.
	Caution! Risk of electric shock.
	USB socket.
	Earth.
	The CE marking indicates conformity with European directives, in particular LVD and EMC.
	Chauvin Arnoux has adopted an Eco-Design approach in order to design this appliance. Analysis of the complete lifecycle has enabled us to control and optimize the effects of the product on the environment. In particular this appliance exceeds regulation requirements with respect to recycling and reuse.
	The rubbish bin with a line through it indicates that, in the European Union, the product must undergo selective disposal in compliance with Directive WEEE 2012/19/EU. This equipment must not be treated as household waste.

Definition of measurement categories:

- Measurement category IV corresponds to measurements taken at the source of low-voltage installations.
Example: power feeders, counters and protection devices.
- Measurement category III corresponds to measurements on building installations.
Example: distribution panel, circuit-breakers, machines or fixed industrial devices.
- Measurement category II corresponds to measurements taken on circuits directly connected to low-voltage installations.
Example: power supply to electro-domestic devices and portable tools.

PRECAUTIONS FOR USE

This instrument and its accessories comply with safety standards IEC 61010-1, IEC 61010-031, and IEC 61010-2-30 for voltages of 1000V in category IV.

Failure to observe the safety instructions may result in electric shock, fire, explosion, and destruction of the instrument and of the installations.

- The operator and/or the responsible authority must carefully read and clearly understand the various precautions to be taken in use. Sound knowledge and a keen awareness of electrical hazards are essential when using this instrument.
- If you use this instrument other than as specified, the protection it provides may be compromised, thereby endangering you.
- Do not use the instrument on networks of which the voltage or category exceeds those mentioned.
- Do not use the instrument if it seems to be damaged, incomplete, or poorly closed.
- Before each use, check the condition of the insulation on the leads, housing, and accessories. Any item of which the insulation is deteriorated (even partially) must be set aside for repair or scrapping.
- Use only the leads and accessories supplied. Using leads (or accessories) of a lower voltage or category reduces the voltage or category of the combined instrument + leads (or accessories) to that of the leads (or accessories).
- Use personal protection equipment systematically.
- Keep your hands away from the terminals of the instrument.
- When handling the leads, test probes, and crocodile clips, keep your fingers behind the physical guard.
- As a safety measure, and to avoid interference, do not move and do not handle the leads during measurements.

CONTENTS

1. FIRST USE	4
1.1. Delivery condition	4
1.2. Accessories	4
1.3. Replacement parts	5
1.4. Specifications label.....	6
1.5. Charging the batteries	6
1.6. Adjusting the brightness and contrast.....	7
1.7. Choice of language.....	8
1.8. Choice of measurement cable compensation	8
2. DESCRIPTION OF THE INSTRUMENT	9
2.1. Functions	10
2.2. Display.....	10
2.3. Keypad	11
2.4. PC software	11
3. PROCEDURE	12
3.1. Using the leads.....	12
3.2. AC/DC voltage measurement	13
3.3. Insulation measurement	13
3.4. Error indications.....	22
3.5. DAR (dielectric absorption ratio) and PI (polarization index).....	22
3.6. DD (dielectric discharge index).....	24
3.7. Capacitance measurement.....	26
3.8. Measurement of the residual current.....	26
4. COMPLEMENTARY FUNCTIONS	27
4.1. TEMP key	27
4.2. ALARM key.....	28
4.3. CONFIG key	28
4.4. DISPLAY key	33
4.5. GRAPH key	33
4.6. FILTER key	34
4.7. HELP key.....	35
5. CONFIGURATION (SET-UP)	36
5.1. Restoring the initial configuration	36
5.2. General parameters.....	37
5.3. Measurement parameters	37
5.4. Adjustment of the test voltages.....	38
5.5. Adjustment of the alarm thresholds	39
6. MEMORY FUNCTION	40
6.1. Recording of the measurements	40
6.2. Reading recorded values.....	42
6.3. Erasing the memory	44
6.4. List of coded errors.....	45
7. DATA TRANSFER SOFTWARE	47
8. SPECIFICATIONS	48
8.1. Reference conditions.....	48
8.2. Characteristics per function	48
8.3. Power supply.....	54
8.4. Environmental conditions	55
8.5. Construction specification.....	55
8.6. Compliance with international standards.....	56
8.7. Variations in the domain of use	56
8.8. Intrinsic uncertainty and operating uncertainty.....	56
9. MAINTENANCE	57
9.1. Maintenance	57
9.2. Updating of the internal software.....	57
9.3. List of parameters.....	58
10. WARRANTY	60

1. FIRST USE

1.1. DELIVERY CONDITION

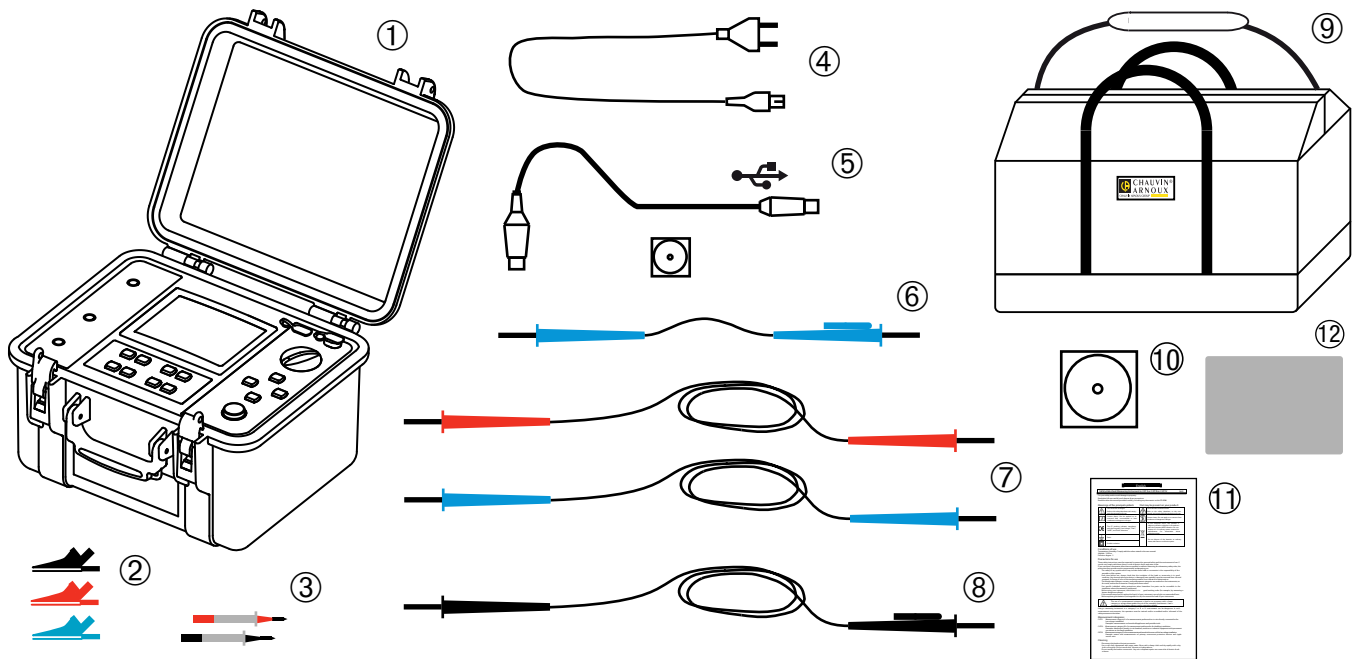

- ① A C.A 6550 or a C.A 6555 with a screen protection film and a rechargeable battery.
- ② Three crocodile clips (red, black, and blue).
- ③ Two test probes (red and black).
- ④ One power cord 2 metres long for recharging the battery.
- ⑤ One data transfer software program and one optical-USB cord.
- ⑥ One safety lead (blue), 0.5m long, with two high-voltage plugs, one of them with a rear pick-up.
- ⑦ Two safety leads (red and blue), 3 metres long, with high-voltage plugs at both ends.
- ⑧ One shielded safety lead (black), 3m long, with two high-voltage plugs, one of them with a rear pick-up.
- ⑨ One carrying bag for the accessories.
- ⑩ One user manual on CD-ROM (one file per language).
- ⑪ One multilingual safety data sheet.
- ⑫ Specifications labels (one per language).

1.2. ACCESSORIES

- Set of 3 shielded safety leads (black, red, and blue), 3 metres long, with a high-voltage plug at one end (with rear pick-up on the black lead) and a large crocodile clip at the other

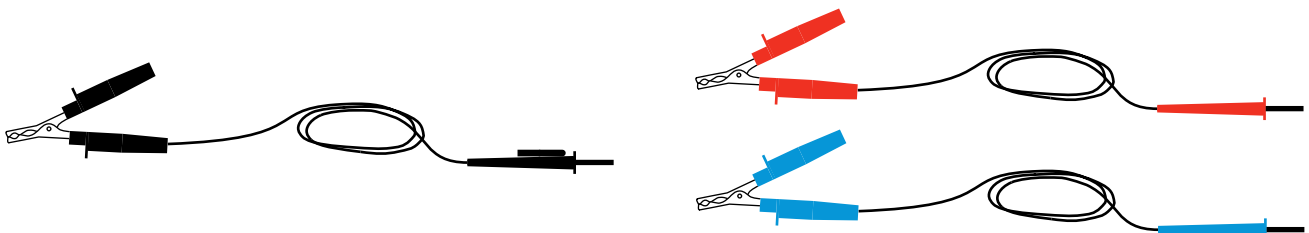

- Shielded safety lead (black), 8 metres long, with a high-voltage plug with rear pick-up at one end and a large crocodile clip at the other
- Safety lead (red), 8 metres long, with a high-voltage plug at one end and a large crocodile clip at the other
- Safety lead (blue), 8 metres long, with a high-voltage plug at one end and a large crocodile clip at the other
- Shielded safety lead (black), 15 metres long, with a high-voltage plug with rear pick-up at one end and
- a large crocodile clip at the other
- Safety lead (red), 15 metres long, with a high-voltage plug at one end and a large crocodile clip at the other
- Safety lead (blue), 15 metres long, with a high-voltage plug at one end and a large crocodile clip at the other
- Thermocouple thermometer C.A. 861
- Thermo-hygrometer C.A.846

1.3. REPLACEMENT PARTS

- One carrying bag
- Set of 3 HV leads, 3 metres long (red, blue, and black with rear pick-up)
- Lead with rear pick-up (blue), 0.5 metre long
- Set of 2 test probes (red and black)
- Set of 3 crocodile clips
- Optical-USB cord
- European 2P mains cord
- Screen protection film

For the accessories and spares, consult our web site:

www.chauvin-arnoux.com

1.4. SPECIFICATIONS LABEL

Attach one of the 5 specifications labels, with your appropriate language, on the inside of the lid.

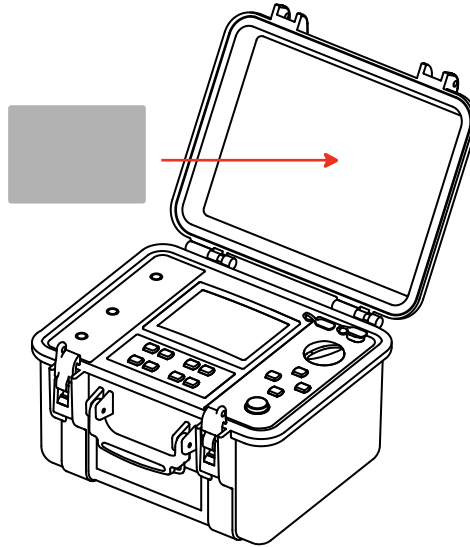

1.5. CHARGING THE BATTERIES

When using the instrument for the first time, start by fully charging the batteries. Charging must be done at a temperature between 0 and 30°C.

Set the switch to OFF.

Connect the mains cord.

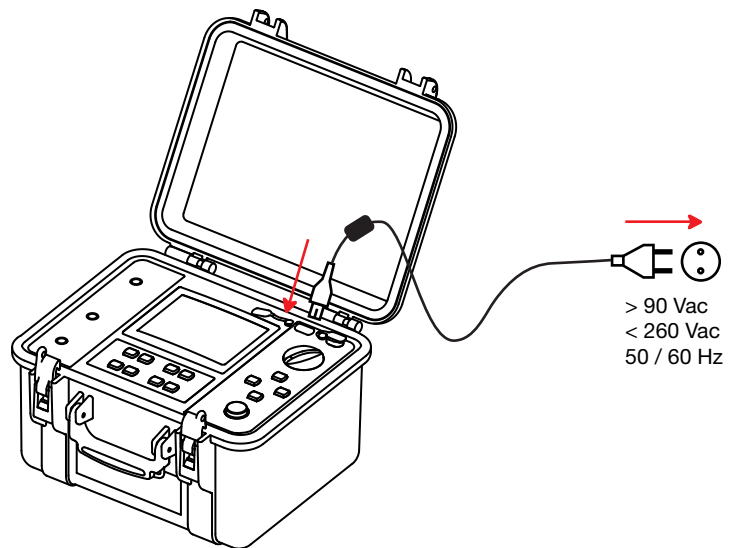
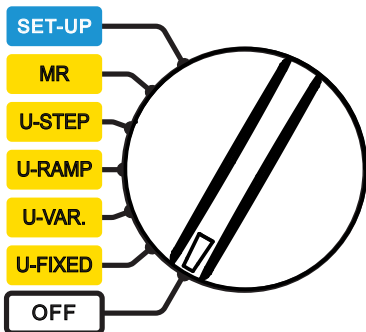

During the charging, the instrument displays the following information:

Battery 1	2%	Charging
	12.4 V	
	1953 mA	
	26.4°C	
	00:05:30	
Battery 2	3%	
	11.7V	
	13 mA	
	26.7°C	
	00:05:20	

The percentage charge of each of the batteries, their voltages, their charging currents, their temperatures, and the charging times.

To reduce the power to be supplied and make it possible to use the instrument during the charging, the batteries are charged alternately at 2A for 10 seconds. It is for this reason that the charging current keeps varying.

The text on the side indicates:

- Charging = battery being charged,
- Full = battery fully charged,
- Cold = battery too cold to be charged,
- Hot = battery too hot to be charged,
- Defect = battery faulty (must be replaced).

Charging time:

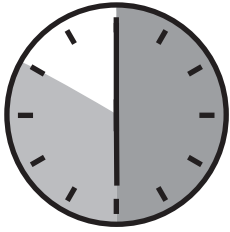

between 6 and 10 hours, depending on the initial charge condition.

Battery 1	100%	Full
	11.4 V	
	15 mA	
	55.1°C	
	02:34:41	
Battery 2	100%	Full
	11.4 V	
	15 mA	
	55.1°C	
	02:34:24	

Following prolonged storage, the batteries may be completely discharged. In this case, the first charge may take longer.

Charging when the instrument is in operation is also possible. In this case the  symbol flashes. The charging current then depends on the test voltage and on the resistance measured. If the power necessary for the measurement approaches 10W, the batteries are no longer charging.

1.6. ADJUSTING THE BRIGHTNESS AND CONTRAST

Press the HELP key for more than two seconds.

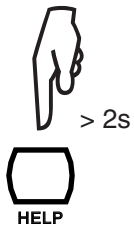

Press the ◀▶ keys to adjust the contrast.
Press the ▲▼ keys to adjust the brightness.

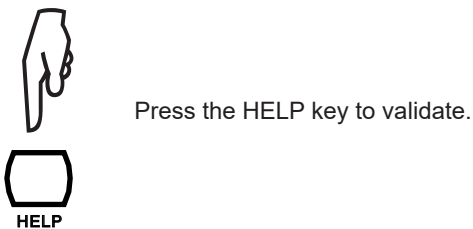
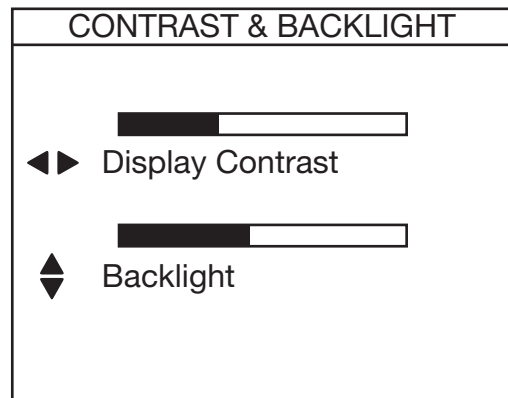

These adjustments are stored even after the instrument is switched off.

1.7. CHOICE OF LANGUAGE

This choice is available only if the version of the electronic boards allows it.

To enter the language selection menu, press the CONFIG key and hold it down while turning the switch to SET-UP.

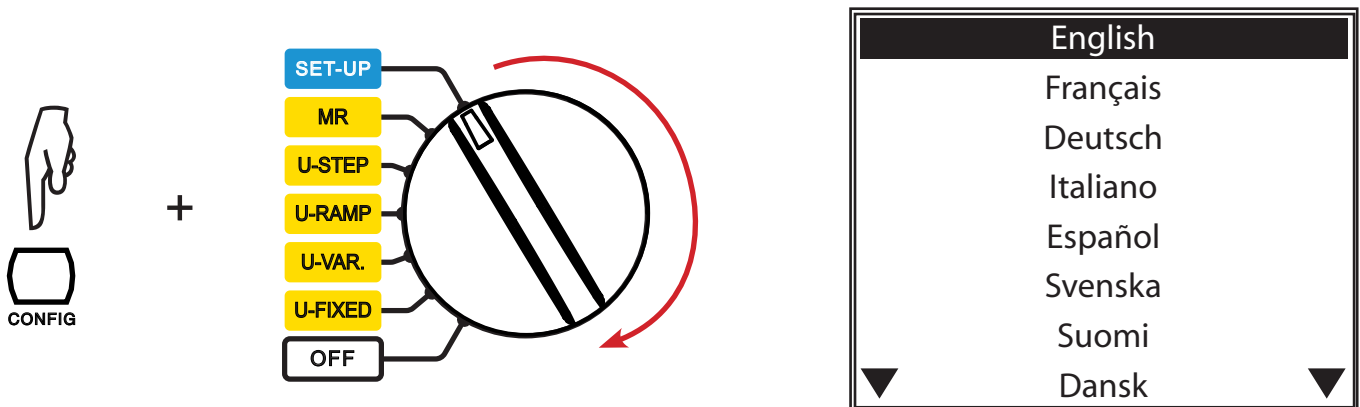

The language selection menu displays all of the languages available. Use the ▲▼ keys to choose your language and press the ► key to confirm or ◀ to cancel.

Installing the new language may take up to 30 seconds. The device then reboots.



1.8. CHOICE OF MEASUREMENT CABLE COMPENSATION

This choice is possible only if the internal software version allows it (see update § 9.2) and only with the red lead delivered with the device (k22 marking at each end).

To enter the cable compensation selection menu, press the FILTER key and hold it down while turning the switch from OFF to SET-UP.

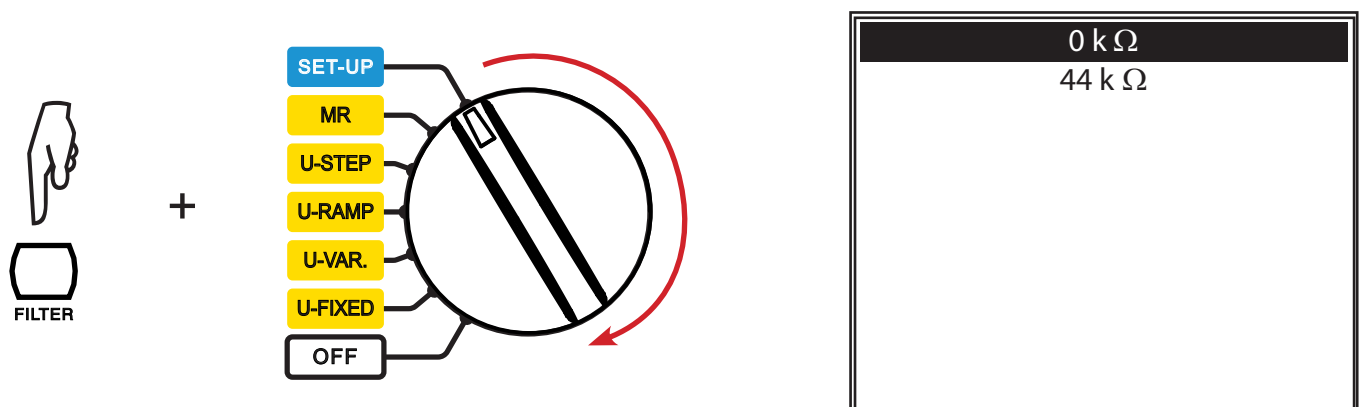

Use the ▲▼ keys to select the compensation and press the ► key to confirm or ◀ to exit.

After a few seconds, the device reboots.

2. DESCRIPTION OF THE INSTRUMENT

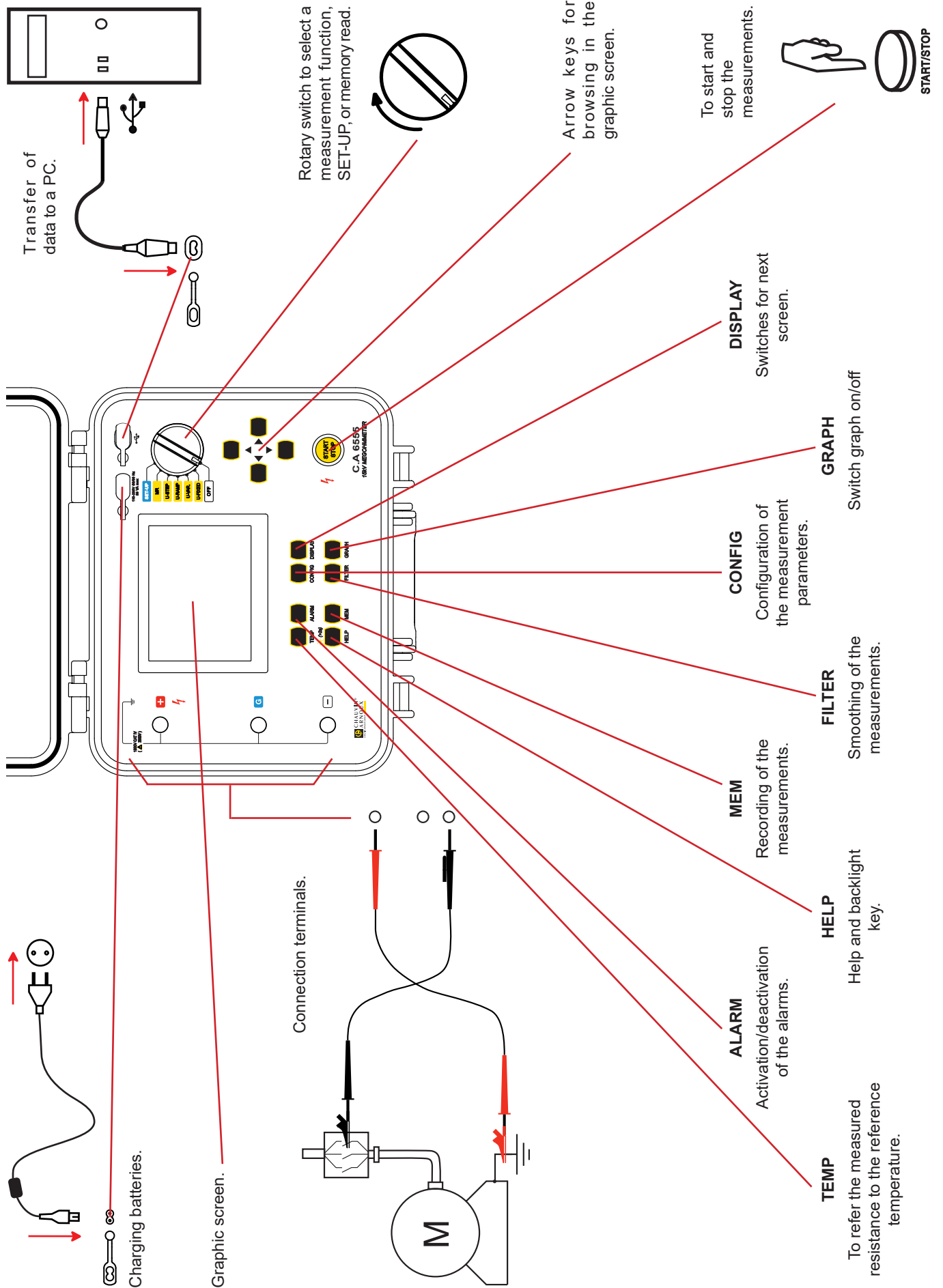

2.1. FUNCTIONS

C.A 6550 and C.A 6555 megohmmeters are high-end portable measuring instruments intended for the measurement of very high electrical insulation and resistance values, mounted in a rugged site housing with a cover; they have graphic screens and can operate on battery or mains power.

The C.A. 6550 makes insulation measurements at voltages up to 10,000V, the C.A. 6555 up to 15,000V.

Their main functions are:

- detection and measurement of input voltage, frequency, and current;
- quantitative and qualitative insulation measurement:
 - measurement at a fixed test voltage of 500, 1,000, 2,500, 5,000, 10,000 or 15,000Vdc;
 - measurement at an adjustable test voltage between 40 and 15,000Vdc;
 - measurement with a voltage ramp in the ranges from 40 to 1,100V or from 500 to 15,000V;
 - measurement with a voltage in steps from 40 to 15,000V;
 - non-destructive (Early break) test, test stopped at a preset current (Break at I-limit) or Burning;
 - calculation of the DAR, PI, and DD (dielectric discharge index) quality ratios;
 - calculation of the measured resistance referred to a reference temperature.
- measurement of the capacitance of the circuit tested;
- measurement of the residual current.

These megohmmeters contribute to the safety of electrical installations and equipment.

Their operation is managed by microprocessors that acquire, process, display, and store the measurements.

They have many advantages, such as:

- digital filtering of insulation measurements;
- measurement of the voltage;
- the programming of thresholds to trigger audible alarms;
- the timer for measurement duration checks;
- the programming of a limitation of the measurement current;
- the plotting of the resistance, voltage, and current vs. time curves and the current vs. voltage curve: R(t), U(t), I(t), and I(U);
- protection of the device by fuse, with detection of defective fuse;
- operator safety thanks to the automatic discharging of the test voltage on the tested device at the end of the measurement;
- automatic power save mode of the device to save battery power;
- indication of battery charge condition;
- large graphic display with backlight capability;
- a memory to store the measurements, a real-time clock, and a USB interface;
- data export to a PC (using the software provided).

2.2. DISPLAY

The display unit is a graphic display with a resolution of 320x240 pixels.

It has built-in back-lighting, which can be controlled by a long press on the  key (see §1.6).

2.2.1. EXAMPLE OF DISPLAY BEFORE THE MEASUREMENT

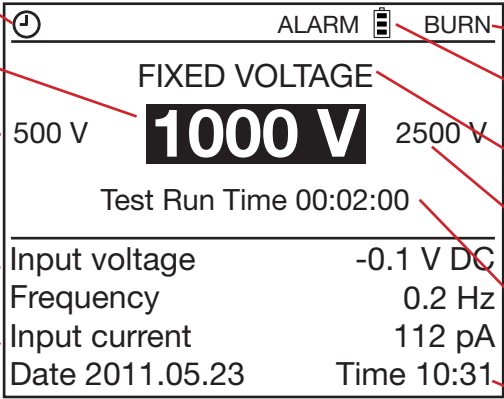

The screenshot shows the following display elements:

- Top status bar: A clock icon, "ALARM" with a battery icon, and "BURN".
- Measurement mode: "FIXED VOLTAGE".
- Test voltage: "1000 V" (blinking).
- Available test voltages: "500 V" (next lower) and "2500 V" (next higher).
- Test Run Time: "00:02:00".
- Input voltage: "-0.1 V DC".
- Frequency: "0.2 Hz".
- Input current: "112 pA".
- Date and time: "Date 2011.05.23" and "Time 10:31".

Annotations on the left side:

- Test with programmed duration. (points to the clock icon)
- The blinking value can be modified using the ▲▼ keys. (points to "1000 V")
- Value of the next lower available test voltage. (points to "500 V")
- Value of the external voltage present on the terminals and its frequency. (points to "-0.1 V DC")
- Current flowing between the terminals. (points to "112 pA")

Annotations on the right side:

- The alarm is enabled. (points to "ALARM")
- No stop at current limit. (points to "BURN")
- Condition of the batteries. (points to the battery icon)
- Type of measurement function. (points to "FIXED VOLTAGE")
- Value of the next higher available test voltage. (points to "2500 V")
- Programmed duration of the test. (points to "00:02:00")
- Date and time. (points to "Date 2011.05.23" and "Time 10:31")

2.2.2. EXAMPLE OF DISPLAY DURING THE MEASUREMENT

The measurement smoothing filtering is active, with a time constant of 20 seconds.

Value of the insulation resistance.

The voltage generated is >70Vdc and therefore dangerous.

True value of the test voltage.

Value of the insulation resistance on the bargraph.

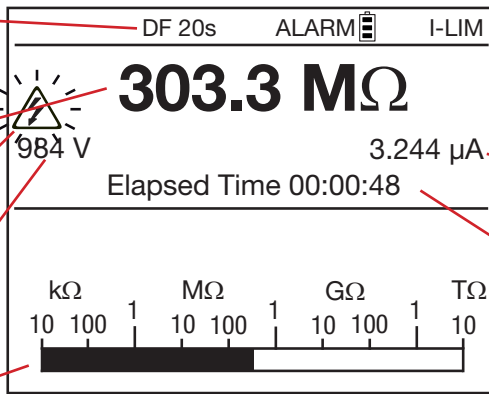

Stop at current limit.

Current flowing between the terminals.

Elapsed time since the beginning of the measurement.

2.2.3. EXAMPLE OF DISPLAY AFTER THE MEASUREMENT

The measurement of the current range is fixed.

Value of the insulation resistance.

True value of the test voltage at the end of the measurement.

Ancillary results.

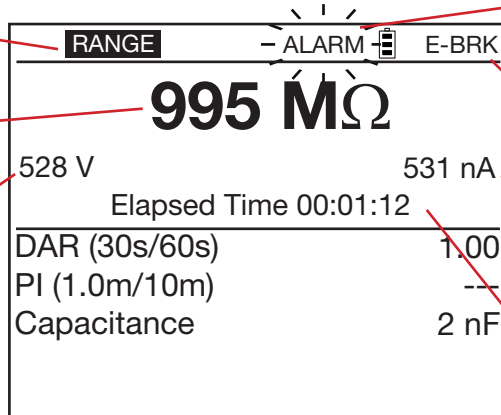

Insulation resistance below the alarm threshold.

The type of measurement is a non-destructive test.

Current at the end of the measurement.

Duration of the measurement.

The  symbol indicates blinking.

If values are undetermined, they are represented by - - - -.

2.3. KEYPAD

If the audible signal has not been deactivated in SET-UP, the instrument confirms each key press by an audible beep. A higher-pitched beep indicates that, pressing the key is prohibited or will have no effect.

A long press (press maintained for more than two seconds) is confirmed by a second audible beep.

2.4. PC SOFTWARE

This Pc software is used to:

- transfer data stored in the instrument,
- print customised test protocols in accordance with user needs,
- create Excel™ spreadsheets,
- Set the instrument up and control it entirely via the USB link.

The recommended minimum configuration is a PC running XP, Vista, or Windows 7.

3. PROCEDURE

When they leave the factory, the C.A. 6550 and C.A. 6555 are configured so that they can be used without modifying the parameters. For most measurements, you simply choose the test voltage and press the START/STOP button.

If you want to modify parameters, most of them can be configured using the CONFIG key, and also in SET-UP.

The SET-UP function allows overall configuration of the instrument independently of which measurement functions are chosen. The CONFIG key allows configuration of the chosen measurement function before and during a measurement.

A configuration modified in one of these two ways is updated for both (SET-UP or CONFIG key).

3.1. USING THE LEADS

Specific leads are supplied with the instrument. To use them, you must add test probes or crocodile clips (also supplied with the instrument).



These accessories have guards. For safety reasons, the user's hands must always be behind the guard.

The positions the hands must not go beyond are indicated below:

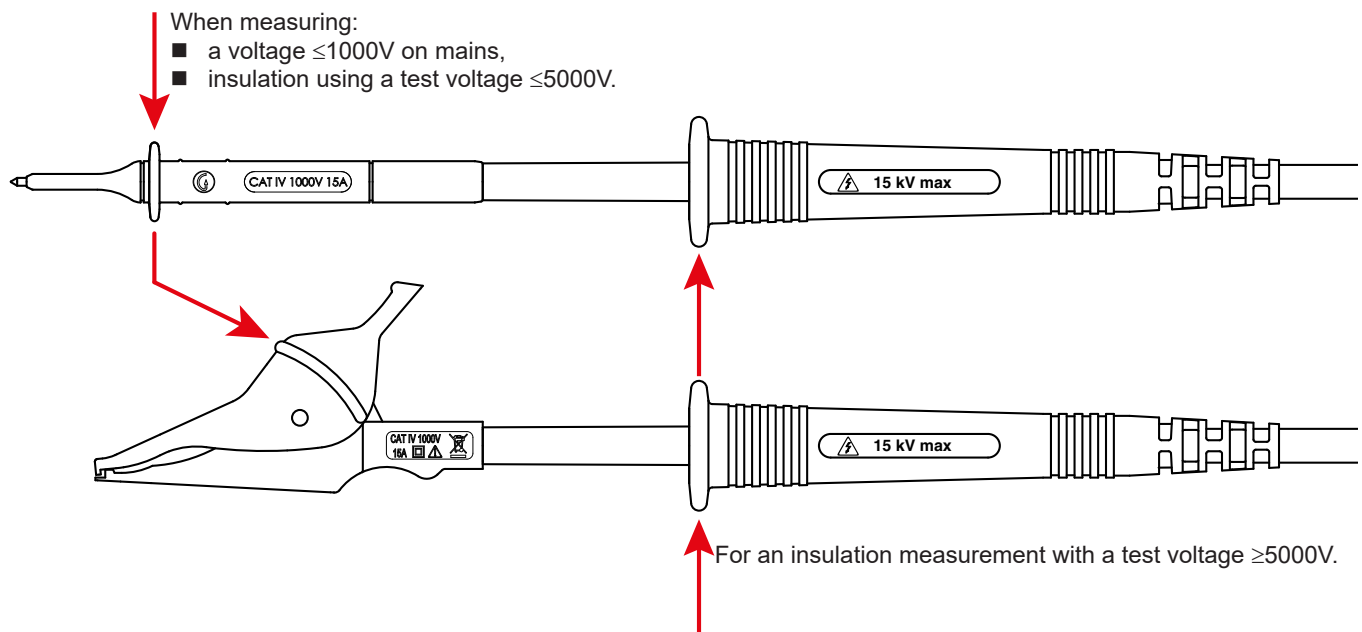

Measurements of voltages $\geq 1000V$ on mains must be made using the test probes only, with the user's hands behind the guard on the lead.

Remark: The leads with large clips (automobile battery charger type) proposed as accessories cannot be used for mains voltage measurements because their jaws are not insulated.

3.2. AC/DC VOLTAGE MEASUREMENT

Turning the switch to any insulation measurement position (U-FIXED, U-VAR, U-RAMP, or U-STEP) sets the instrument to AC/DC voltage measurement. The voltage between the input terminals is measured at all times and indicated as RMS value on the display unit: Input Voltage. Switching between AC and DC mode is automatic.

In the case of an AC signal, the instrument measures the frequency. It also measures the residual DC current between the terminals of the instrument. This measurement is used to evaluate its impact on the insulation measurement about to be made.

The insulation measurements cannot be started if there is an excessively high external voltage ($>0.4 U_N$ where U_N is the test voltage, with a maximum of 1000 VAC) on the terminals.

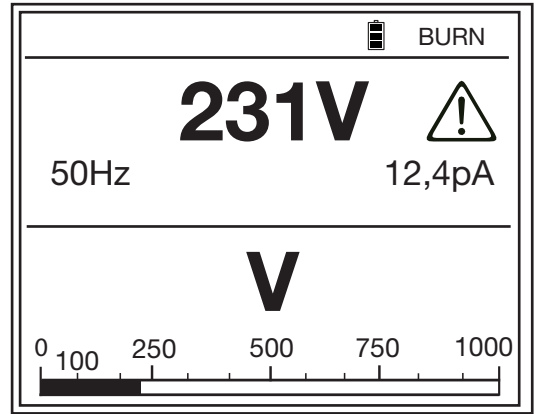
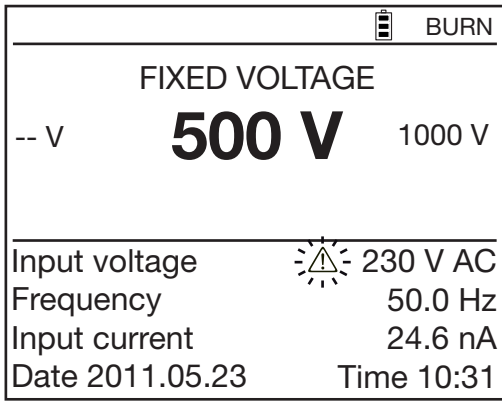

When the external voltage exceeds 25V, the blinking (⚠) symbol is displayed alongside it.

The only errors possible in a voltage measurement are:

- The frequency is outside the measurement range (see §8.2.1)
- The voltage is outside the measurement range (see §8.2.1).

3.3. INSULATION MEASUREMENT



The insulation measurement is made on an object that is not live.

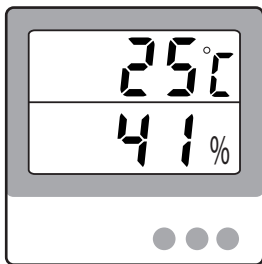

This measurement varies greatly with the temperature and the relative humidity. It is therefore essential to measure them using a separate device (see §1.2) and to record them with the insulation value.

The ambient temperature and relative humidity can be entered in the instrument as parameters and stored with the measurement result (see §4.1).

The value of the test voltage is generally twice the voltage at which the object to be tested is used, unless a standard stipulates otherwise.

For example, for a motor that operates on 230V mains, the test will be performed at 500V.

3.3.1. DESCRIPTION OF THE MEASUREMENT PRINCIPLE

The instrument generates a DC test voltage equal to the chosen nominal voltage U_N between the + and - terminals. More precisely, the value of this voltage depends on the resistance to be measured (see the curves of §8.2.3). The instrument measures the voltage and the current between the two terminals and from them deduces $R=V/I$.

The instrument measures the external voltage present on the terminals. It can make the measurement if the peak voltage is less than $0.4 U_N$ or 1000 VAC maximum. Above this value, it does not make the measurement.

3.3.2. WITH A FIXED VOLTAGE

Set the switch to U-FIXED

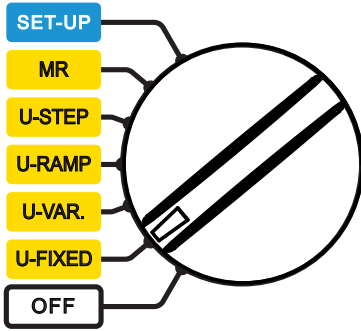

The following screen appears.

BURN	
FIXED VOLTAGE	
-- V	500 V 1000 V
Input voltage	10 V AC
Frequency	50.0 Hz
Input current	24 pA
Date 2011.05.23	Time 10:31

Use the ▲▼ keys to select the test voltage: 500, 1 000, 2 500, 5 000, 10 000, or 15 000Vdc,

The device generates exactly the voltage selected if the resistance to be measured is indeed greater than $R_N = U_N / 1\text{mA}$. If the resistance measured is $\leq R_N$, the output voltage is less than U_N . In this case, use the U-VAR function and adjust U so that the voltage displayed during the test is at the desired value (see §4.3.2).

3.3.3. WITH A VARIABLE VOLTAGE

Set the switch to U-VAR.

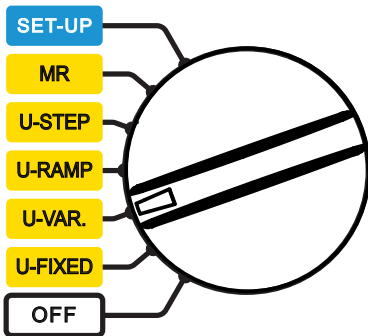

The following screen appears.

BURN	
ADJUSTABLE VOLTAGE 1	
50 V	
Input voltage	0.1 V AC
Frequency	0.2 Hz
Input current	11 pA
Date 2011.05.24	Time 15:31

There are already 3 preset voltages that can be modified in SET-UP (see §5). Use the ▲▼ keys to select one of them:

- Adjustable Voltage 1: 50V
- Adjustable Voltage 2: 800V
- Adjustable Voltage 3: 7,000V

Otherwise, use the ◀▶ keys to go to the voltage value, then use the ▲▼ keys to adjust the value of the test voltage. The adjustment is in 10V steps up to 1,000V, then in 100V steps. Keep the keys pressed to speed up the adjustment.

BURN	
ADJUSTABLE VOLTAGE	
750 V	
Input voltage	0.1 V AC
Frequency	0.2 Hz
Input current	11 pA
Date 2011.05.24	Time 15:31

3.3.4. WITH A VOLTAGE RAMP

This test is based on the principle that an ideal insulation produces the same resistance whatever the test voltage applied.

Any negative variation of the insulation resistance therefore means that the insulation is defective: the resistance of defective insulation decreases as the test voltage increases. This phenomenon is barely observable with low test voltages. At least 2,500V must therefore be applied.

Since the application of the voltage is gradual, it causes no premature ageing or deterioration of the device tested. Unlike the increase in steps, the gradual increase of the current means that the capacitive current is constant. A variation of the current therefore directly represents a variation of the insulation resistance.

Evaluating the result:

- a negative slope of the resistance versus test voltage curve exceeding 500ppm/V generally indicates the presence of mildew or other deterioration.
- a larger negative slope, or a sudden drop, indicates the presence of localized physical damage (arcing, perforation of the insulation, etc.).

The test with a voltage ramp is ideally suited for testing semiconductors (diodes, transistors, and thyristors). Take care in this case to choose a non-destructive type of test: Break at I-limit (see § 4.3.1) and a maximum output current less than or equal to 1 mA.

Set the switch to U-RAMP.

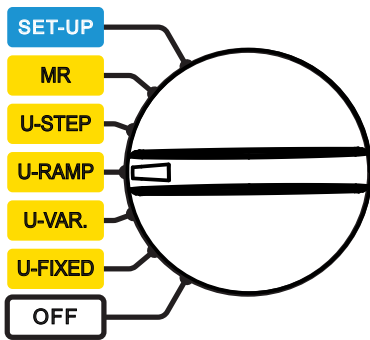

The following screen appears:

BURN		
RAMP FUNCTION 1		
Min. 50 V		Max. 500 V
Test Run Time 00:03:00		
Input voltage	-0.1 V DC	
Frequency	0.2 Hz	
Input current	55.7 nA	
Date 2011.05.24	Time 15:31	

Use the ▲▼ keys to select a preset test voltage ramp:

Ramp function 1: 50 to 500V

Ramp function 2: 500 to 5,000V

Ramp function 3: 1,000 to 10,000V

The voltages at the beginning and end of the ramp can be programmed with the CONFIG key (see §4.3). The duration of the test is the sum of the three durations specified: the duration of the initial plateau, the duration of the ramp, and the duration of the final plateau.

3.3.5. WITH A STEPPED VOLTAGE

The preset stepped voltage tests have ten plateaus. The duration of each of the voltage plateaus is identical. At the end of each plateau, the capacitive current should be zero and only the measurement current remains.

Unlike the ramp test, the step test stresses the insulation and can cause a breakdown. A sudden increase of the current (or a sudden decrease of the insulation resistance) means that a breakdown point is near. It is then possible to discontinue the measurement by hand (by pressing the START/STOP button) or automatically (E-BRK or Break at I-Limit type of test; see §4.3.1).

A drop of 25% or more between the insulation resistance of one plateau and the next plateau is a sign of deterioration of the insulation. Set the switch to U-STEP.

The following screen appears.

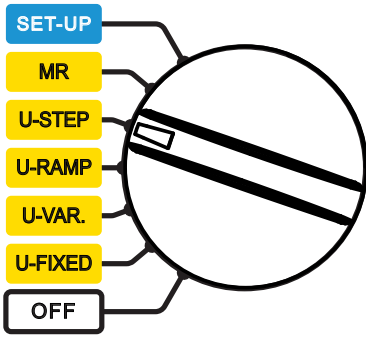

Use the ▲▼ keys to choose the

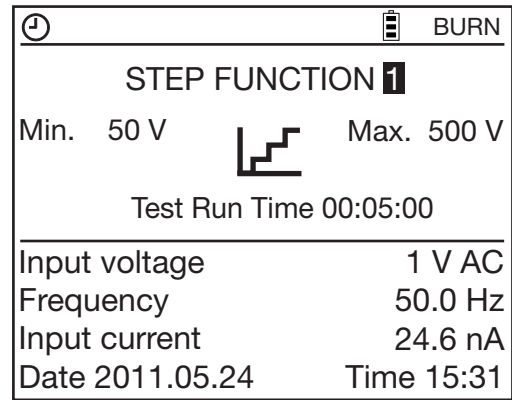

preset step type of test:
 Step function 1: 50 to 500V
 Step function 2: 500 to 5.000V
 Step function 3: 1.000 to 10.000V

The values of the voltages of each step, the number of steps, and the duration of each step can be programmed using the CONFIG key (see §4.3).

3.3.6. CONNECTION

Depending on the measurements to be made, there are three ways of connecting the instrument.

In all cases, disconnect the device to be tested from mains.

■ Low insulation

Connect the red high-voltage lead between earth and the + terminal of the instrument. Connect the black high-voltage lead between one phase of the motor and the - terminal of the instrument.

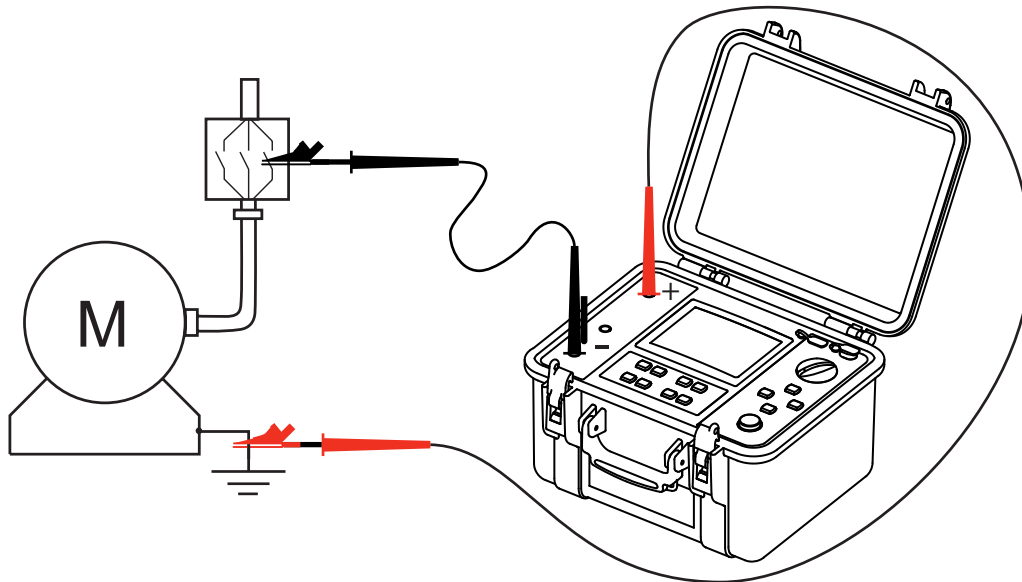

■ **High insulation**

For very high insulation values, connect the small blue high-voltage lead between the rear pick-up of the black lead and the G terminal of the instrument in order to avoid leakage current and capacitive current effects or to eliminate the influence of the surface leakage current.

This reduces the influence of the operator's hands and gives a more stable measurement.

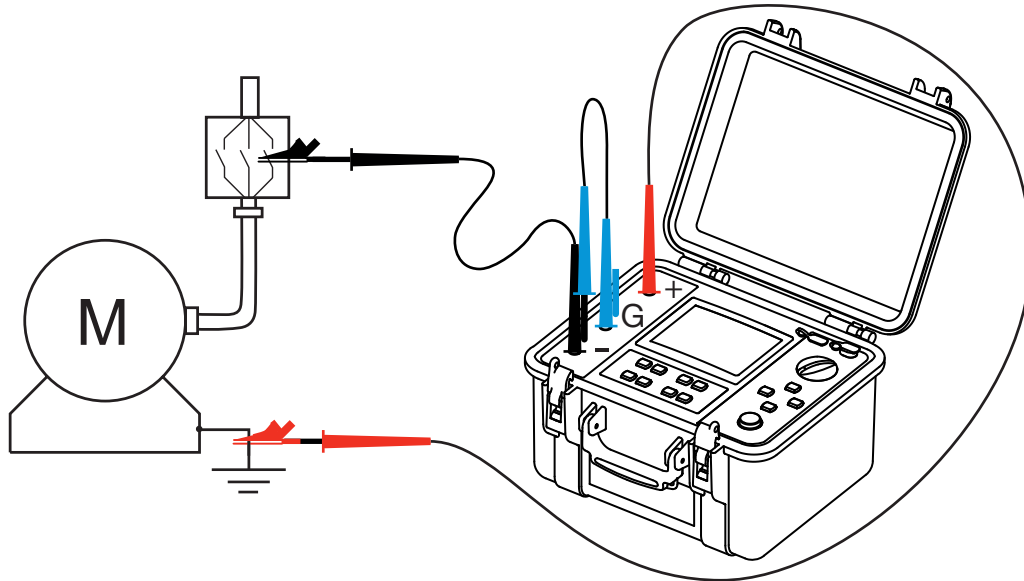

■ **Cable**

Connect the red high-voltage lead between the braid and the + terminal of the instrument.
Connect the black high-voltage lead between the core and the - terminal of the instrument.
Connect the blue high-voltage lead between the insulation and the G terminal of the instrument.

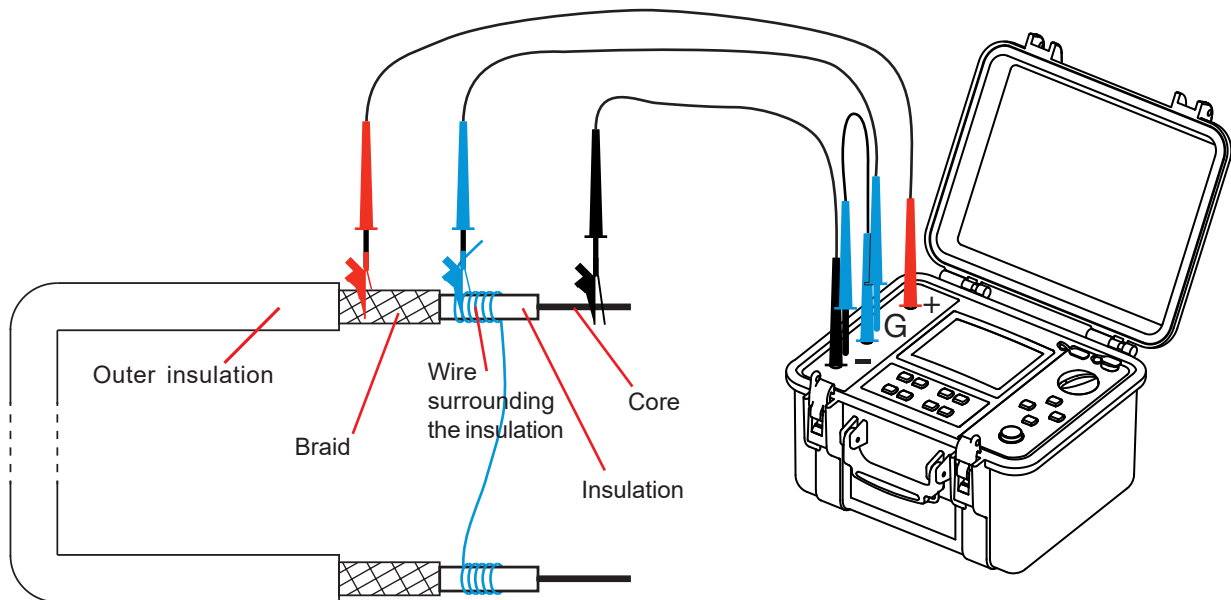

Using the guard eliminates the influence of the surface leakage current.
A conducting wire must be wrapped round the insulation.

3.3.7. BEFORE THE MEASUREMENT

It is possible to configure the measurement using the CONFIG key



If the U-FIXED or U-VAR. test voltages have been selected, it is possible to select a measurement configuration by pressing the CONFIG key (see §4.3):

- Manual Stop
- Manual Stop + DD
- Timed Run
- Timed Run + DD
- DAR
- PI



Then set the type of test, the maximum current, the current range, the filtering of the measurement, and the value of the alarm threshold:

- Test Type
- Maximum Output Current
- I-range
- Disturbance Level
- Alarm



To enable the alarm, press the ALARM key. An audible beep will sound if the result of the measurement is below the programmed threshold.

Remark: the DISPLAY key is used to change between different screens of the same menu. While re-entering a menu, the last used screen is shown.

3.3.8. DURING THE MEASUREMENT

Press the START/STOP button to start the measurement.



The instrument generates the high voltage. To indicate that the measurement is in progress, the instrument emits an audible beep every ten seconds (if the buzzer is switched on) and the START/STOP button lights red.



If the test voltage generated is >5000V, the START/STOP button blinks.

At the end of a few seconds, the measurement is displayed in digital form and in analog form on a bargraph.

If the measurement is unstable, it is possible to apply a digital filter in addition by pressing the FILTER key (see §4.6).

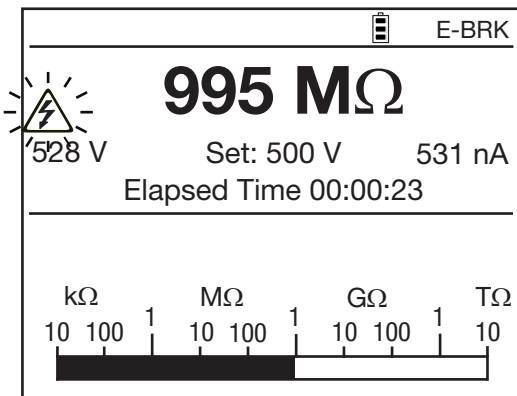

It is possible to view the available numerical values by pressing the DISPLAY key.

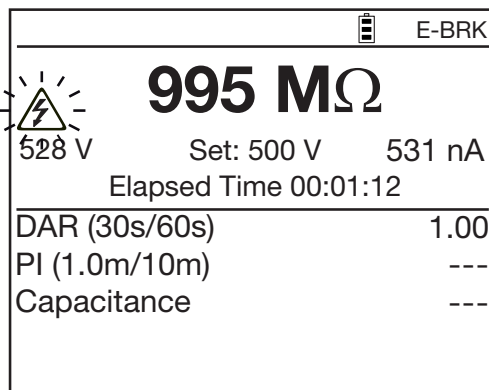

In the case of a step test voltage (10 steps at most) or ramp test voltage (3 steps), the progress of the steps is indicated.

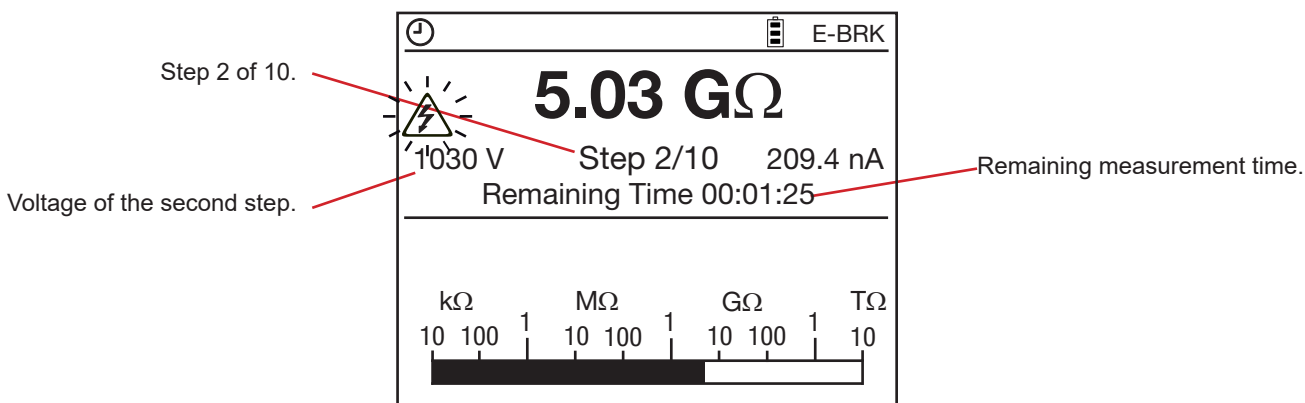

You can view the graphical representation of the measurement results by pressing the GRAPH key. For more details, refer to § 4.5.

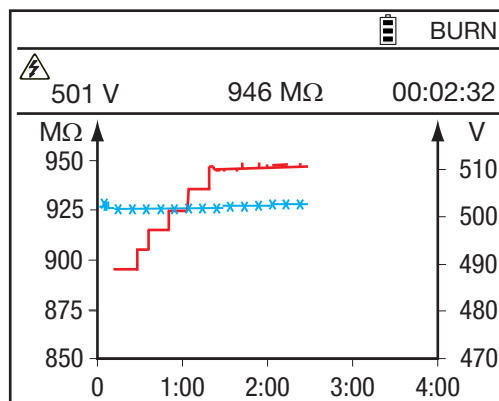

For U-VAR and U-FIXED it is also possible to change measurement parameters during the measurement by pressing the CONFIG key. It is possible to fix the current measurement range, to add an analogue filter, or to change the test voltage if in the variable test voltage mode U-VAR. For more details, refer to § 4.3.



In the case of a ramp measurement, the resistance displayed is always greater than the true resistance because of the permanent capacitive current due to the permanent variation of the voltage. The value displayed will be exact only at the end of the test, during the voltage plateau.



When the instrument is configured for a manual stop, once the measurement obtained is stable, press the START/STOP button again to stop the measurement. In the other cases (programmed duration: Timed Run, Timed Run + DD, DAR, PI, U-RAMP, or U-STEP), the measurement stops automatically at the end of the test.

At the end of the measurement, the instrument switches back to voltage measurement, but usually the result of the insulation resistance measurement remains displayed. To display the voltage, press the DISPLAY key. In case of an external voltage >25V is present, the instrument automatically switches to the screen with the test description screen and input voltage indication.

Annotations for the screenshot:

- Value of the insulation resistance:** 995 MΩ
- Value of the test voltage at the end of the measurement:** 528 V
- Ancillary results:** DAR (30s/60s), PI (1.0m/10m), Capacitance
- Type of test:** E-BRK
- The alarm is enabled and the insulation resistance is below the alarm threshold:** - ALARM
- Current at the end of the measurement:** 531 nA
- Duration of the measurement:** Elapsed Time 00:01:12

3.3.9. AFTER THE MEASUREMENT

Once the measurement has been stopped, the instrument discharges the device being tested in a few seconds. For your safety, therefore, wait a little before disconnecting the leads. Normally, this happens rapidly and the user is unaware of it. But if the load is highly capacitive, the discharging time is longer. In this case, for as long as the voltage exceeds 25V, the instrument so indicates on the display.

Display content:

- Top right: E-BRK
- Center: 381V with a warning triangle icon
- Below: DC
- Large V symbol
- Bottom: A scale from 0 to 1000 with a bar graph indicator.

Display content:

- Top right: E-BRK
- Center: 995 MΩ
- Below: 502 V and 503 nA
- Elapsed Time 00:01:20
- Table of results:

DAR (30s/60s)	1.00
PI (1.0m/10m)	---
Capacitance	<1 nF



The DISPLAY key is used to look up all information available after the measurement. This information depends on the type of measurement chosen (see §4.4).

In the case of a ramp or step measurement, the measurement result is displayed as follows:

Test with programmed duration.

Value of the insulation resistance.

Value of the test voltage at the end of the measurement.

ΔR : difference of insulation resistance between the resistance at the highest test voltage and the resistance at the lowest test voltage.

ΔV : difference between the highest test voltage and the lowest test voltage.

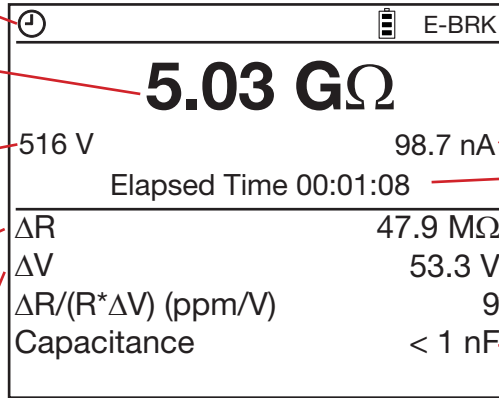

Current at the end of the measurement.

Duration of the measurement.

Voltage coefficient in ppm/V.

Capacitance of the device tested. Record the measurement and

compare it to earlier measurements in order to assess the evolution of its value. Also record the temperature and the ambient relative humidity.

If, at equivalent temperature and humidity, the insulation resistance has fallen significantly, the insulation is deteriorated and maintenance must be carried out on the device tested.

The result remains displayed until another measurement is made, the switch is turned, or the measurement configuration is changed.



Pressing the GRAPH key displays the graphical representation of the measurement results (see §4.5).



In U-FIXED and U-VAR modes pressing the TEMP key opens the temperature menu (see §4.1).



Pressing the MEM key opens the recording menu (see §6.1).



At any time, you can press the HELP key for a reminder of the functions of the keys.



3.4. ERROR INDICATIONS

The most common error in the case of an insulation measurement is the presence of a voltage on the terminals.

The instrument can make the measurement if the peak value of this voltage is less than $0.4U_N$ or 1000 V AC maximum. Above this value, it is necessary to eliminate the voltage and repeat the measurement.

If an external voltage appears on the terminals during the measurement, and its peak value is greater than $1.1U_N$, the measurement is broken off and the error is indicated.

3.5. DAR (DIELECTRIC ABSORPTION RATIO) AND PI (POLARIZATION INDEX)

In the U-VAR and U-FIXED functions, in addition to the quantitative value of the insulation resistance, it is very useful to calculate the quality ratios of the insulation (the DAR and the PI) because they can eliminate the influence of certain parameters likely to invalidate the “absolute” insulation measurement. They also serve to predict the evolution of insulation quality over time.

The main parameters influencing the measurement results are:

- temperature and relative humidity, with which insulation resistance varies according to a quasi-exponential law.
- the disturbance currents (capacitive charging current, dielectric absorption current) created by the application of the test voltage. Even if they gradually fade, they perturb the measurement at the start, for a more or less long time depending on whether the insulation is sound or degraded.

These ratios therefore complete the “absolute” insulation value and reliably reflect the condition, good or bad, of the insulation.

In addition, long-term observation of the evolution of these ratios is a way to monitor the ageing of the insulation. For example, that of a revolving machine or of a long cable.

The values of DAR and PI are calculated as follows:

$$DAR = R_{1 \text{ min}} / R_{30 \text{ s}} \quad (2 \text{ values to be determined during a 1-min measurement})$$

$$PI = R_{10 \text{ min}} / R_{1 \text{ min}} \quad (2 \text{ values to be determined during a 10-min measurement})$$

The time of 1 and 10 minutes for the calculation of the PI and the times of 30 seconds and 1 minute for the calculation of the DAR can be modified in the CONFIG menu or in SET-UP (see § 5), to adapt to particular applications.

3.5.1. MEASUREMENT

There are several ways of measuring the DAR and the PI:

■ In manual configuration

Press the START/STOP button.



Wait one minute for the DAR or ten minutes for the PI (if the default values are used).

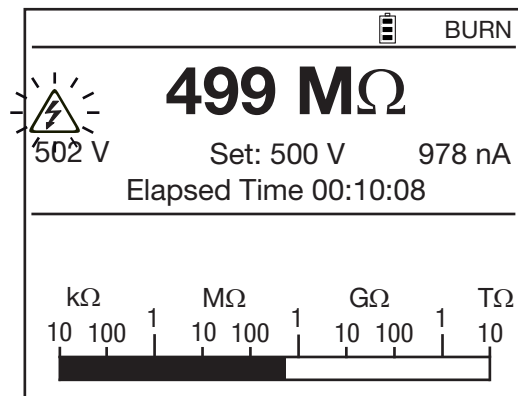

Press the START/STOP button again to stop the measurement.



BURN	
502 MΩ	
502 V	978 nA
Elapsed Time 00:10:10	
DAR (30s/60s)	2.64
PI (1.0m/10m)	1.05
Capacitance	320 nF

■ In automatic configuration (preferable)

Press the CONFIG key.



CONFIG	
Total Run Time	---
▶ Manual Stop	
Manual Stop + DD	
Timed Run (m:s)	2:00
Timed Run + DD	
DAR (s/s)	30/60
PI (m/m)	1.0/10

Use the ▲▼keys to select DAR or PI.

CONFIG	
Total Run Time	00:01:00
Manual Stop	
Manual Stop + DD	
Timed Run (m:s)	2:00
Timed Run + DD	
▶ DAR (s/s)	30/60
PI (m/m)	1.0/10

CONFIG	
Total Run Time	00:10:00
Manual Stop	
Manual Stop + DD	
Timed Run (m:s)	2:00
Timed Run + DD	
DAR (s/s)	30/60
▶ PI (m/m)	1.0/10

Press CONFIG to exit from the configuration menu. DAR or PI is displayed in the top left corner of the display unit to indicate the configuration chosen.



Press the START/STOP button to start the measurement. It stops automatically and the values of DAR and PI are displayed.



3.5.2. INTERPRETATION OF THE RESULTS

DAR	PI	Condition of insulation
DAR < 1,25	PI < 1	Poor or even dangerous
	1 ≤ PI < 2	
1,25 ≤ DAR < 1,6	2 ≤ PI < 4	Good
1,6 ≤ DAR	4 ≤ PI	Excellent

A capacitance in parallel to the insulation resistance extends the settling times of the measurements. This can affect or even inhibit the measurement of DAR or PI (depending on the time set for recording the first resistance value). The table below indicates the typical values of the capacitances in parallel with the insulation resistance, making it possible to measure the DAR and the PI without changing their preset durations.

	100 kΩ	1 MΩ	10 MΩ	100 MΩ	1 GΩ	10 GΩ	100 GΩ
500 V	10 μF	10 μF	10 μF	6 μF	4 μF	2 μF	1 μF
1,000 V	5 μF	5 μF	5 μF	3 μF	2 μF	1 μF	0.5 μF
2,500 V	2 μF	2 μF	2 μF	1.2 μF	1 μF	0.5 μF	0.2 μF
5,000 V	1 μF	1 μF	1 μF	0.6 μF	0.4 μF	0.3 μF	0.1 μF
10,000 V	0.5 μF	0.5 μF	0.5 μF	0.3 μF	0.2 μF	0.1 μF	0 μF
15,000 V	0.3 μF	0.3 μF	0.3 μF	0.2 μF	0.1 μF	0.1 μF	0 μF

3.6. DD (DIELECTRIC DISCHARGE INDEX)

In the case of multilayer insulation, if one of the layers is defective but the resistance of all the others is high, neither the quantitative insulation measurement nor the calculation of the PI and DAR quality ratios will reveal the problem.

This makes it judicious to perform a dielectric discharge test, from which the DD term can be calculated. This test measures the dielectric absorption of heterogeneous or multilayer insulation and disregards parallel-surface leakage currents.

The dielectric discharge test is especially well suited to measuring the insulation of revolving machines and more generally for measuring the insulation on heterogeneous or multi-layer insulating materials containing organic substances.

It involves applying a test voltage for long enough to electrically “charge” the insulation to be measured (typically, a voltage of 500 V is applied for 30 minutes). At the end of the measurement, the instrument induces rapid discharging, during which the capacitance of the insulation is measured, then, one minute later, it measures the residual current flowing in the insulation.

The DD term is then calculated as follows:

$$DD = \text{current measured after 1 minute (mA)} / [\text{test voltage (V)} \times \text{measured capacitance (F)}]$$

3.6.1. MEASUREMENT

Press the CONFIG key.



CONFIG	
Total Run Time	---
▶ Manual Stop	
Manual Stop + DD	
Timed Run (m:s)	2:00
Timed Run + DD	
DAR (s/s)	30/60
PI (m/m)	1.0/10

Use the ▲▼keys to select Manual Stop + DD or Timed Run + DD (manual or automatic measurement).

CONFIG	
Total Run Time	---
Manual Stop	
▶ Manual Stop + DD	
Timed Run (m:s)	2:00
Timed Run + DD	
DAR (s/s)	30/60
PI (m/m)	1.0/10

CONFIG	
Total Run Time	00:03:00
Manual Stop	
Manual Stop + DD	
Timed Run (m:s)	2:00
▶ Timed Run + DD	
DAR (s/s)	30/60
PI (m/m)	1.0/10

To set the duration of the measurement, place the cursor on Timed Run (m:s). Then use the ◀▶ and ▲▼ keys to set the minutes and seconds. The minimum setting is 0:01, but the setting should not be less than 30 seconds because acquiring a stable resistance result takes some time.

CONFIG	
Total Run Time	00:02:00
Manual Stop	
Manual Stop + DD	
▶ Timed Run (m:s)	2:00
Timed Run + DD	
DAR (s/s)	30/60
PI (m/m)	1.0/10

Once the duration has been set, move the cursor back to Timed Run + DD.

Press CONFIG to exit from the configuration menu. DD or ⌚ DD is displayed in the top left corner of the display unit to indicate the configuration chosen.



Press the START/STOP button to start the measurement.



In the Manual Stop + DD configuration, wait until the elapsed time is the desired test time, then press the START/STOP button to stop the measurement.

In the Timed Run + DD configuration (indicated by the ⌚ symbol), the measurement stops automatically.

In both cases, it is necessary to wait one minute after the measurement is stopped (countdown on the display unit) for the instrument to display the result. During this time, the START/STOP button is lit but the instrument does not emit an audible signal.

The result is then displayed.



⌚ DD	BURN
234.5 MΩ	
507 V	224.6 pA
Elapsed Time 00:02:00	
DAR (30s/60s)	1.42
PI (1.0m/10m)	---
Capacitance	2 nF
DD current	11 pA
DD	2.55

3.6.2. INTERPRETATION OF THE RESULT

Value of DD	Quality insulation
$7 < DD$	Very poor
$4 < DD < 7$	poor
$2 < DD < 4$	Borderline
$DD < 2$	Good

3.7. CAPACITANCE MEASUREMENT

The capacitance measurement is made automatically after the insulation measurement, and is displayed after the measurement has been stopped and the device tested has been discharged.

3.8. MEASUREMENT OF THE RESIDUAL CURRENT

The measurement of the residual current flowing in the device tested is made automatically as soon as the connection to the device tested is made, then during and after the insulation measurement.

4. COMPLEMENTARY FUNCTIONS

4.1. TEMP KEY

This function is accessible only when the measurement is over and only for U-VAR and U-FIXED. It is used to refer the measurement result to a temperature other than the one at which the measurement was made.

This is because the temperature causes the resistance to vary according to a quasi exponential law. To a rough approximation, raising the temperature by 10°C halves the insulation resistance; conversely, lowering the temperature by 10°C doubles the insulation resistance.

Referring the measurements to a single temperature makes it easier to compare them and gives a better idea of the evolution of the insulation resistance. And this is true whatever the temperature at the time of the measurement.

Similarly, measuring the humidity improves the correlation between the various measurements made on a given device.

Procedure:

- Make a measurement in U-FIXED or U-VAR mode.
- Press the TEMP key.



TEMPERATURE	
▣ Ambient Temperature	--- °C
Humidity	--- %
Probe Temperature	--- °C
Rc Reference Temperature	--- °C
ΔT for R/2	--- °C
R measured	5.00 G Ω
Rc at --- °C	--- k Ω

- Use the ◀▶ and ▲▼ keys to enter the various parameters:
 - Air Temperature: the ambient temperature (optional)
 - Humidity: the ambient relative humidity (optional)
 - Probe Temperature: the temperature of the device tested.
 - Rc Reference Temperature: the temperature to which the measured resistance will be referred.
 - ΔT for R/2: the temperature variation, known or estimated, sufficient to halve the insulation resistance.
- To facilitate the programming, the instrument proposes default values.
- The instrument then displays the insulation resistance referred to the reference temperature.

TEMPERATURE	
▣ Ambient Temperature	23 °C
Humidity	40%
Probe Temperature	23 °C
Rc Reference Temperature	40 °C
ΔT for R/2	10 °C
R measured	5.00 G Ω
Rc at 40 °C	1.529 G Ω

If coefficient ΔT for R/2 is not known, it can be calculated from a minimum of 3 measurements made on the same device at different temperatures.

Detail concerning the calculation performed:

The insulation resistance varies with the measurement temperature. This dependence can be approximated by an exponential function:

$$R_c = K_T * R_T$$

- where R_c : insulation resistance referred to 40°C.
- R_T : insulation resistance measured at temperature T.
- K_T : coefficient defined as follows:

$$K_T = (1/2)^{((40 - T)/\Delta T)}$$

where ΔT : temperature difference at which the insulation resistance is halved.

4.2. ALARM KEY



Press the ALARM key to enable the alarm defined using the CONFIG key (see 4.3) or in SET-UP (see §5). The ALARM symbol is then displayed.

If the measurement is less than the alarm threshold, the instrument so indicates by the blinking of the ALARM symbol on the display unit and the emission of an audible signal.



Press the ALARM key again to disable the alarm; the ALARM symbol disappears from the display unit.

4.3. CONFIG KEY

4.3.1. BEFORE THE MEASUREMENT

If the U-FIXED or U-VAR. test voltages have been chosen, there are two configuration screens. There is only one for the U-RAMP and U-STEP test voltages.

Press the CONFIG key (press CONFIG key again to exit):



CONFIG	
Total Run Time	---
▶ Manual Stop	
Manual Stop + DD	
Timed Run (m:s)	2:00
Timed Run + DD	
DAR (s/s)	30/60
PI (m/m)	1.0/10

- Manual Stop: manual stop of the measurement.
- Manual Stop + DD: manual stop of the measurement and calculation of the DD.
- Timed Run (m:s): automatic stop of the measurement at the end of the programmed duration.
- Timed Run + DD: automatic stop of the measurement at the end of the programmed duration and calculation of the DD.
- DAR: automatic stop of the measurement at the end of one minute (or of the programmed time, if different).
- PI: automatic stop of the measurement at the end of 10 minutes (or of the programmed time, if different).

It is always possible to stop a measurement during a test with programmed duration, by pressing the START/STOP button.

The ▲ ▼ keys are used to select the measurement configuration. All the changes are immediately valid.

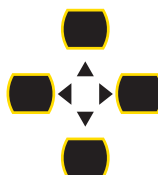

When you select Timed Run (test with programmed duration) or Timed Run + DD, you can set the duration of the measurement (m:s). To do this, use the ◀▶ and ▲▼ keys.

CONFIG	
Total Run Time	00:02:00
Manual Stop	
Manual Stop + DD	
▶ Timed Run (m:s)	2:00
Timed Run + DD	
DAR (s/s)	30/60
PI (m/m)	1.0/10

The test will last the time programmed. However, if, during the

measurement, the rotary switch is turned or the START/STOP button is pressed, the measurement will be broken off. Press the DISPLAY key to see the second configuration screen.

The ▲▼ keys are used to select and modify a parameter.



CONFIG	
▶ Test Type	Burning
Maximum output current	1.0 mA
I-Range	Auto
Disturbance Level	Low
Alarm	< 2.5 MΩ

The chosen configuration is immediately valid. The second configuration screen depends on the setting of the switch.

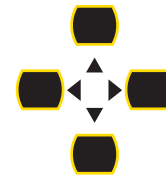

The U-RAMP and U-STEP settings do not use the first page of the configuration screen, only the second.

The second configuration screen is used to choose:

■ **The type of test (Test Type)**

Nondestructive test (Early break)

The measurement will be stopped at the first breakdown current peak detected. This type of test is used for non-destructive tests. The current is limited to 0.2 mA.

The E-BRK symbol is displayed.

Stoppage of the test at a preset current (Break at I-limit)

E-BRK	
FIXED VOLTAGE	
500 V	1000 V 2500 V
Input voltage	10 V AC
Frequency	50.0 Hz
Input current	24 pA
Date 2011.05.23	Time 10:31

The measurement will be stopped when the current reaches the maximum value (Maximum Output Current) defined by the user (see below). This type of test is useful for testing varistors or other types of voltage limiter.

The I-LIM symbol is displayed.

Burning

I-LIM	
FIXED VOLTAGE	
500 V	1000 V
2500 V	
Input voltage	10 V AC
Frequency	50.0 Hz
Input current	24.6 nA
Date 2011.05.23	Time 10:31

The measurement is not stopped, whatever the value of the current. Depending on the application, this type of test can be used to determine the position of insulation faults when there is Burning: appearance of an electric arc during the test or burn spot after the test.

The BURN symbol is displayed.

■ **The maximum current (Maximum Output Current)**

BURN	
FIXED VOLTAGE	
500 V	1000 V
2500 V	
Input voltage	10 V AC
Frequency	50.0 Hz
Input current	24.6 nA
Date 2011.05.23	Time 10:31

This is the current not to be exceeded during the test.

Use the ▲▼ keys to set it to between 0.2 and 5mA for the Burning and Break at I-limit test types. For the Early break test type, this value is fixed at 0.2 mA.

■ **The current range (I-range)**

This function is used to make measurements more rapidly when their order of magnitude is already known.

Use the ▲▼ keys to set its value to Auto or to a fixed value. Then choose the current range:

Current	< 300 nA	60 nA < I < 50 µA	10 µA < I < 6 mA	Auto
Current range	300 nA	50 µA	7 mA	Auto

For example for $U_N = 10,000 \text{ V}$:

Current range	300 nA	50 µA	7 mA
Resistance	$R > 30 \text{ G}\Omega$	$200 \text{ M}\Omega < R < 16,6 \text{ G}\Omega$	$10 \text{ M}\Omega^* < R < 1 \text{ G}\Omega$

* : $10 \text{ M}\Omega$ because $I_{max} = 1 \text{ mA}$ at $10,000 \text{ V}$.

The fixed current range remains active until the instrument is switched off.

The RANGE symbol is displayed.

RANGE			BURN
FIXED VOLTAGE			
500 V	1000 V	2500 V	
Input voltage		10 V AC	
Frequency		50.0 Hz	
Input current		24.6 nA	
Date 2011.05.23	Time 10:31		

- Perturbation of the signal (Disturbance Level)
Use the ▲▼ keys to set its value, from Low to High. The DH symbol is then displayed.

DH			
FIXED VOLTAGE			
500 V	1000 V	2500 V	
Input voltage		10 V AC	
Frequency		50.0 Hz	
Input current		24.6 nA	
Date 2011.05.23	Time 10:31		

Setting to High is recommended when you make measurements in the presence of strong electromagnetic fields at the network frequency (for example near high-voltage lines).

- In the U-FIXED and U-VAR modes: the alarm threshold
Use the ▲▼ keys to set the alarm threshold. The alarm threshold can also be set in SET-UP (see §5.5)
The ALARM symbol is displayed and the device emits an audible signal if the alarm is active.

ALARM			BURN
FIXED VOLTAGE			
500 V	1000 V	2500 V	
Input voltage		10 V AC	
Frequency		50.0 Hz	
Input current		24.6 nA	
Date 2011.05.23	Time 10:31		

- In the U-RAMP mode: the programming of the ramp (Set Ramp Function).
Use the ▲▼ keys to go to Set Ramp Function; the instrument displays the voltage ramp values programming screen. This programming can also be done in SET-UP (see §5.4).

- In the U-STEP mode: the programming of the step (Set Step Function).
Use the ▲▼ keys to go to Set Step Function; the instrument displays the voltage step values programming screen. This programming can also be done in SET-UP (see §5.4).

4.3.2. DURING THE MEASUREMENT

During the measurement, in the U-VAR and U-Fixed modes only, the CONFIG key is used to choose the current range: automatic (default) or fixed.
For more details, refer to the previous section.

Once the measurement has started, press the CONFIG key. Press CONFIG key again to exit from the menu.



The following screen appears (in U-FIXED mode):

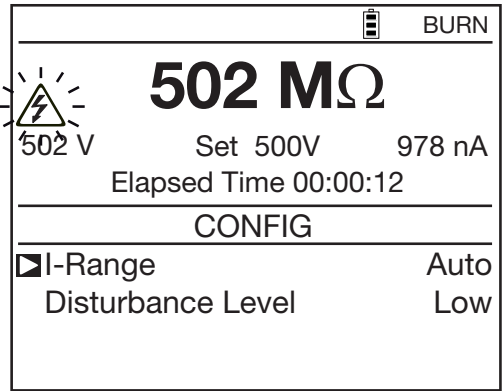

Use the ◀▶ and ▲▼ keys to modify the measurement current range:



The changes are recorded directly after being entered. If the range is fixed, the RANGE symbol is displayed. The change of parameters remains active until the instrument is switched off.

During the measurement, it is also possible to activate and deactivate the analogue filter of the measurement (Disturbance Level).
For more details, refer to the previous section.
In the case of a variable test voltage, the voltage set is also displayed and can be modified during the measurement.

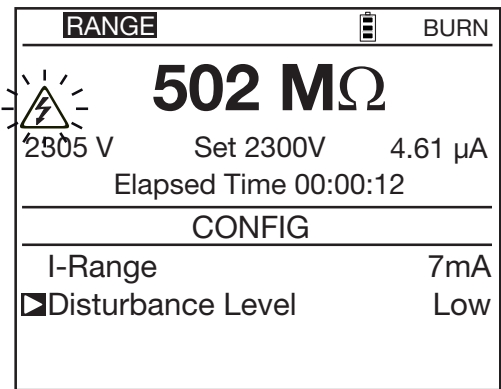

4.4. DISPLAY KEY

This key is used to browse through the various accessible screens.

4.5. GRAPH KEY



During the measurement and at the end of each measurement, pressing the GRAPH key displays a graphical presentation of the measurement results. The first screen shows the insulation resistance versus time $R(t)$ and the voltage versus time $U(t)$.

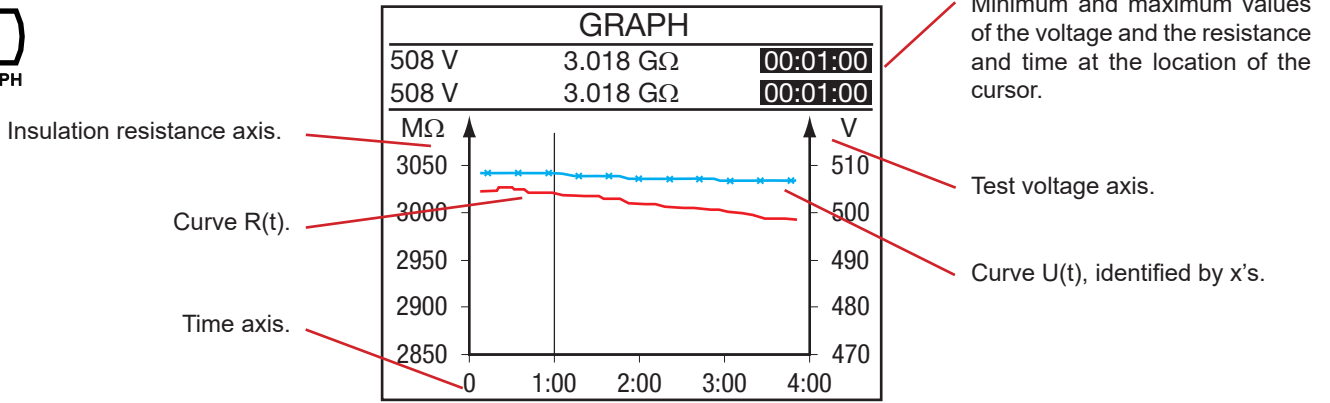

This curve is plotted using samples recorded during the measurement.

During a measurement: There is no cursor, each new result of a measurement is automatically added to the curve and the values are visible on a line above the graphic zone.

After a measurement: The time shown at top right in the screen blinks; this indicates that the cursor mode is active. The ◀ ▶ keys can be used to move the cursor to a different time along the curve. Above the graphic zone, the minimum and maximum values at the cursor position are visible on two lines. If the time period is 4 minutes (the smallest possible), these lines are the same and represent one sample.

Depending on the range of the left-hand vertical scale, it may be possible to shift the vertical scale and the corresponding curve using the ▲ ▼ keys.

In the case of a measurement in U-RAMP or U-STEP mode, this gives:
If the interval of the scale of an axis is big enough it is possible to zoom.

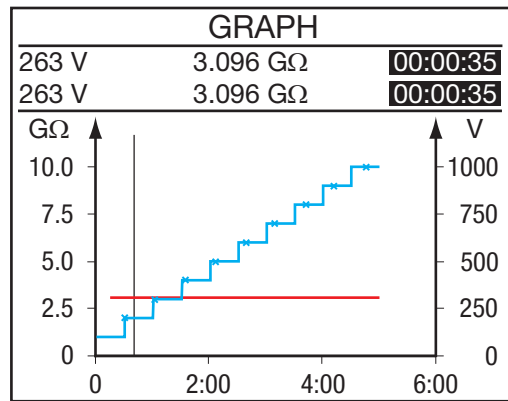
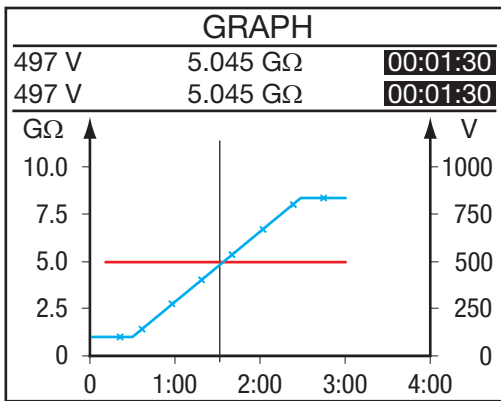

Press the CONFIG key.



The time indication in the upper right of the screen stops blinking, indicating that the zoom mode is active. The ◀ ▶ keys are used to modify the time scale of the graph. The ▲ ▼ keys are used to modify the resistance scale of the graph.

Press the DISPLAY key to view the current vs. time curve.

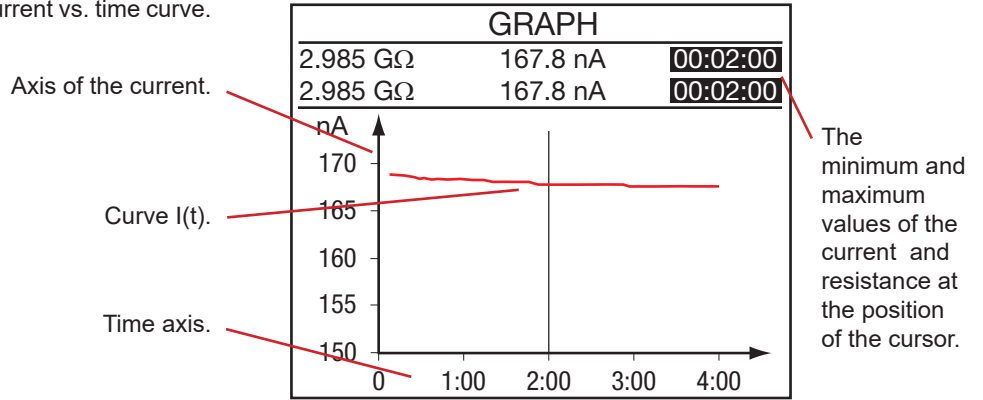

Press the DISPLAY key again to view the current vs. voltage curve (not available for U-STEP).

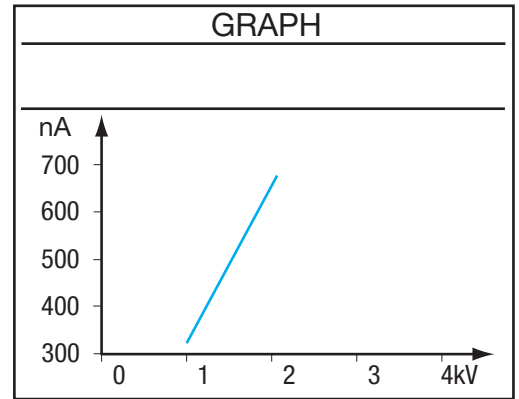

This curve is useful primarily in the case of a measurement in U-RAMP mode. There is no cursor and it is not possible to zoom on this curve.

4.6. FILTER KEY

The FILTER key can be used to activate and deactivate a digital filter for the insulation measurements. This filter affects the displayed values of resistance, voltage and current and the recorded data of the resistance, but not the recorded data of voltage and current. The recorded data of voltage and current remain raw (unfiltered).

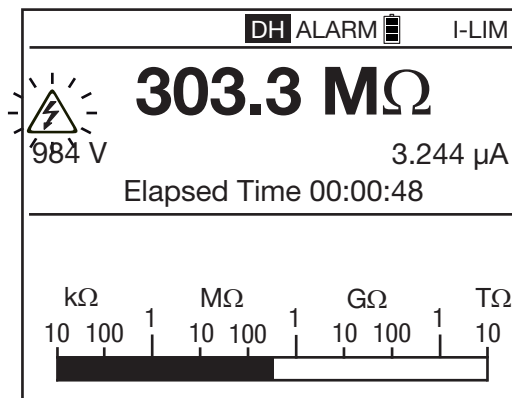

This function is useful in case of high instability of the insulation values displayed, but it is also possible to estimate the measurement on the bargraph.



Successive presses on the FILTER key modify or remove the filter:

- no filter,
- DF 10: time constant 10 seconds,
- DF 20: time constant 20 seconds,
- DF 40: time constant 40 seconds,
- DF: automatic filter, adapts the filter time to the resistance result changes.

The standard setting at power on is automatic filter (DF).

When using a filter it can take a long time (up to several minutes) to recover from an overload resistance value (e.g. >2 TΩ). If you encounter an overload it is best to switch the filter off until a good resistance result is reached again. The filter is calculated as follows:

$$R_N = R_{N-1} + (R - R_{N-1})/N$$

If N is set to 20, the time constant of this filter will be approximately 20 seconds.

Selecting digital filtering is recommended for measurements of

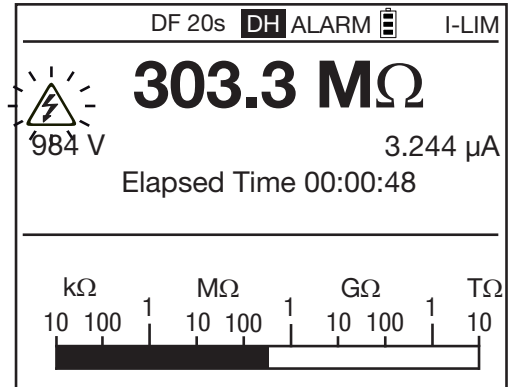

fluctuating high insulation resistance values. Such fluctuations may be due to hand effects, fluctuating capacitances in the device tested, insulation that varies because of conducting dust, an ionizing and polarizing effect of this dust, etc., or again to the presence of an AC voltage superposed on the measurement.

The FILTER key is active before and during the measurement.

4.7. HELP KEY



A short press on the HELP key opens the help function, in which the actions of the keys are explained.

This operation changes with the context. Below, an example in U-FIXED mode:

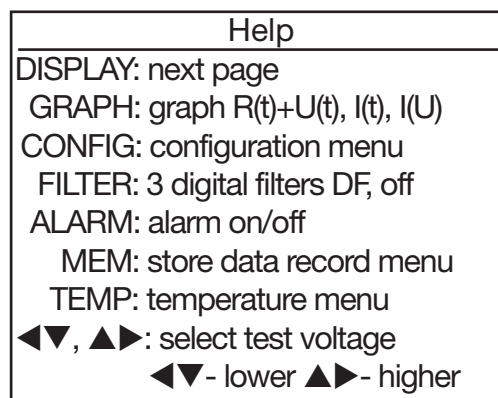

> 2s

A long press on the HELP key lets you set the contrast of the display unit and the backlighting (see §1.6)

5. CONFIGURATION (SET-UP)

This function is used to change the configuration of the instrument by directly accessing the parameters to be modified.

Set the switch to SET-UP.

The following screen appears.

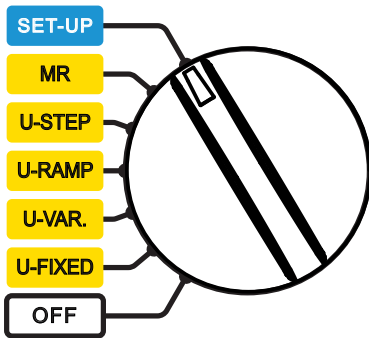

General Settings	
<input checked="" type="checkbox"/> Set Default Parameter	
Buzzer	1
Power Down	On
Baud rate	38400
Date	2011-05-25
Time	9:41
Temperature Unit	Celsius
Instrument Number	100213
Firmware	1.0/1.0

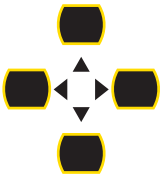

To select and modify a parameter, use the ▲, ▼, ◀ and ▶ arrow keys.

As soon as a parameter is modified, it is recorded.

5.1. RESTORING THE INITIAL CONFIGURATION

To return to the initial configuration, choose **Set Default Parameter**.

The instrument requests confirmation.



If you accept by choosing OK, the following data will be modified:

- The audible level of the buzzer returns to 1.
- The automatic switching off of the instrument will be deactivated.
- The data rate will be 38400 bauds.
- The duration of the measurements with programmed duration will be 2 minutes.
- The sampling duration will be "Min." = minimum (about 1 second).
- The DAR will be 30/60 and the PI 1/10.
- The type of test will be Burning.
- The maximum output current will be 5mA.
- The maximum output voltage will be 10kV (15kV for the C.A. 6555).
- The adjustable test voltages will be 50, 800 and 7000V.
- The ramp and step test voltages return to their original values, as do all alarm thresholds.
- The backlight will be switched off.

5.2. GENERAL PARAMETERS

Buzzer: to set the audible level of beeps: 1, 2, 3, or Off (no sound).

Power down: automatic switching off of the instrument: On (power off at the end of 5 minutes), Off (no power off).

Baud rate: to set the data rate on the serial interface to 9600, 19200, 38400 or 57600 bauds.

Date: to set the date in yyyy-mm-dd format.

Time: to set the time in hh:mm format.

Temperature unit: to choose the unit of temperature: Celsius or Fahrenheit.

Instrument Number: indicates the number of the instrument. This line is informative and cannot be modified.

Firmware: indicates the two version numbers of the firmware in the instrument. This line is informative and cannot be modified.

5.3. MEASUREMENT PARAMETERS

Press the DISPLAY key to see the following screen:



Test Timing	
▣ Timed Run (m:s)	2:00
DAR (s/s)	30/60
PI (m/m)	1.0/10

Timed Run: to set the measurement duration (in minutes:seconds) for measurements with programmed duration.

The adjustment range is from 0:01 to 99:59, in 1-second steps.

DAR: to set the time at which the measurements must be recorded to calculate the DAR (see §3.5). This can be used in special applications.

The first time can be set from 10 to 90 seconds in 5-second steps.

The second time can be set from 15 to 180 seconds in 5-second steps.

PI: to set the time at which the measurements must be recorded to calculate the PI (see §3.5). This can be used in special applications.

The first time can be set from 0.5 to 30 minutes in 0.5- then 1-minute steps.

The second time can be set from 0.5 to 90 minutes in 0.5-, 1-, and 5-minute steps.

Press the DISPLAY key to see the following screen:

Test Type: to choose the type of test: Burning, Early-Break, or



Test Parameters	
▣ Test Type	Burning
Maximum Output Current	5.0 mA
Maximum Output Voltage	15000 V
Adjustable Voltage 1	50 V
Adjustable Voltage 2	800 V
Adjustable Voltage 3	7000 V

Break at I-Limit (see § 4.3.1).

Maximum Output Current: to set the maximum output current, from 0.2 to 5mA for the Burning and Break at I-limit test types; it is fixed at 0.2 mA for the Early break test type.

Maximum Output Voltage: to set the maximum output voltage. This can be useful to prevent handling errors. It make it possible to entrust the instrument to less experienced users, for particular applications (telephony, aviation, etc.) in which it is important not to exceed some maximum test voltage.

For example, if the maximum voltage is set to 750V, the measurement will be made at 500V for the 500V fixed voltage, and at a maximum of 750V for all the other fixed voltages.

The adjustment range is from 40 to 10,000V (15,000 V for the C.A 6555).

5.4. ADJUSTMENT OF THE TEST VOLTAGES

Always on the third SET-UP screen.

Adjustable Voltage 1, 2, and 3: to set the values of the 3 adjustable test voltages.

The adjustment range is from 40 to 15000V.

Press the DISPLAY key to see the following screen.



Step & Ramp Functions	
<input checked="" type="checkbox"/>	Set Step Function 1
	Set Step Function 2
	Set Step Function 3
	Set Ramp Function 1
	Set Ramp Function 2
	Set Ramp Function 3

Set Step Function 1, 2, and 3: in the case of a measurement with a stepped voltage, used to set the voltages and the durations of the steps.

Pressing the ► key opens the following screen:

Step & Ramp Functions		
Step Function 1		
Step	Voltage	Duration (m:s)
<input checked="" type="checkbox"/> 1	50 V	0:30
2	100 V	0:30
3	150 V	0:30
4	200 V	0:30
5	250 V	0:30
Total Run Time (m:s)		5:00

Press the DISPLAY key to see the next screen.



Step & Ramp Functions		
Step Function 1		
Step	Voltage	Duration (m:s)
<input checked="" type="checkbox"/> 6	300 V	0:30
7	350 V	0:30
8	400 V	0:30
9	450 V	0:30
10	500 V	0:30
Total Run Time (m:s)		5:00

You can then set the voltage and duration of each of the 10 steps. The total duration of the measurement (Total Run Time) is calculated by the instrument.

The adjustment range of the voltages is from 40 to 15,000V. If a voltage is set to zero, the voltage displayed is --V.

The duration of the steps ranges from 00:10 to 99:59 and 0. If a duration is set to 0, the time displayed is -:-.

During the test, the instrument waits until the voltage is well stabilized before making the measurement. This being the case, the duration of the step may exceed the time programmed.

The setting should not be less than 30 seconds, because acquiring a stable resistance result takes some time. If either a step voltage or a step duration is set to zero, the step as a whole will be set to zero and will be skipped during the test.

Press the ◀ to exit the menu and return to the main SET-UP menu.

Set Ramp Function 1, 2, and 3: in the case of a measurement with a ramped voltage, used to set the starting voltage, the slope of the ramp, and the final voltage.

Pressing the ► key opens the following screen:

Step & Ramp Functions		
Ramp Function 1:		
Step	Voltage	Duration (m:s)
▣ Start	50 V	0:30
Ramp		2:00
End	500 V	0:30
Total Run Time (m:s)		3:00
$\Delta V/\Delta t$		5V/s

You can then set the voltage and duration of the starting plateau and of the final plateau, along with the duration of the ramp. The total duration of the measurement (Total Run Time) is calculated by the instrument. The voltages can be adjusted in two ranges: between 40 and 1,100V or between 500 and 15000V. The duration of the steps can range from 00:10 (Start 0:30, Ramp 0:10, End 0:10) to 99:59.

Press the ◀ to exit the menu and return to the main SET-UP menu.

5.5. ADJUSTMENT OF THE ALARM THRESHOLDS

Press the DISPLAY key to see the following screen.



Alarm Settings	
▣ 500 V	< 500 k Ω
1000 V	< 1.0 M Ω
2500 V	< 2.5 M Ω
5000 V	< 5.0 M Ω
10000 V	< 10 M Ω
15000 V	< 15 M Ω
Adjustable Voltage 1	< 50 k Ω
Adjustable Voltage 2	< 100 k Ω
Adjustable Voltage 3	< 250 k Ω

These are the alarm thresholds below which the audible alarm is triggered. There is one for each fixed or adjustable voltage, and all of them can be modified. The adjustment of the number is independent of the adjustment of the units.

For a test voltage of 500V, the alarm threshold is adjustable from 10k Ω to 2.0T Ω .
 For a test voltage of 1,000V, the alarm threshold is adjustable from 10k Ω to 4.0T Ω .
 For a test voltage of 2,500V, the alarm threshold is adjustable from 10k Ω to 10T Ω .
 For a test voltage of 5,000V, the alarm threshold is adjustable from 10k Ω to 16T Ω .
 For a test voltage of 10,000V, the alarm threshold is adjustable from 10k Ω to 25T Ω .
 For a test voltage of 15,000V, the alarm threshold is adjustable from 10k Ω to 30T Ω .

For the adjustable test voltages, the alarm threshold depends on the voltage.

A further press on the DISPLAY key is used to return to the first SET-UP screen.

6. MEMORY FUNCTION

6.1. RECORDING OF THE MEASUREMENTS

It is possible to record each insulation measurement once it is over. It is not possible to record the voltage measurements.

These measurements are recorded at addresses identified by an object number (OBJ) and a test number (TEST).

An object can contain 99 tests. An object can therefore represent a machine or an installation on which a certain number of measurements will be made.

At the end of the measurement, press the MEM key.



The instrument proposes recording the result at the first available location in memory. It is possible to modify the numbers proposed using the ◀▶ and ▲▼ keys.

MEMORY			
0	----- 100%		
Obj. Test	Date	Time	Fct.
▶ 01 01	2011-05-26	09:04	500V

If the screen does not display the measurement and **pressing the MEM key has no effect**, press the DISPLAY key twice to restore the result screen, then press the MEM key again. This may happen following the discharging of a highly capacitive load.

Press the MEM key again to confirm the location of the record.



The instrument then asks you if you want to Store Samples with the measurement.

MEMORY			
0	----- 100%		
Obj. Test	Date	Time	Fct.
01 01	2011-05-26	09:04	500V
▶ Store Samples			Yes
Sample Time (m:s)			Min.

If you do this, you can then display the curve of the measurement by a single press on the GRAPH key (see §4.5). If this is not useful, set Store Samples to Off. If you set Store Samples to Yes, you can set the Sample Time using the ◀▶ and ▲▼ keys.

- The default sampling time is the minimum, meaning that all samples acquired during the measurement are recorded.
- The sampling time can be set to Auto (automatic), in which case the instrument itself determines the samples necessary for the plotting of the curve while using the least possible space in memory. If the measurement does not vary, it will take only one value, giving a perfectly flat curve.
This value is recommended to optimize memory use.
- The sampling time can also be programmed, between 1 and 25 seconds.
 - The longer the measurement, the longer the sampling time can be. For example, on a measurement lasting 10 minutes, the sampling time can be 10 seconds, giving 60 points for the curve, which is sufficient.
 - Again, the more stable the measurement, the longer the sampling time can be. And the more unstable the measurement, the shorter the sampling time must be in order to correctly display variations of the insulation resistance.

Press the MEM key one last time to record the measurement.



The instrument confirms the storage.

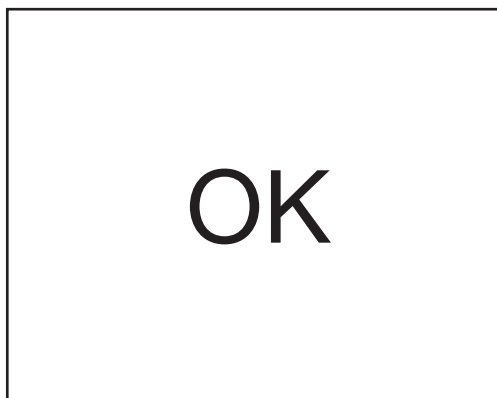

The measurement is recorded with all its supporting information: the date, the time, the measurement mode, the duration of the measurement, the measurement configuration, the test voltage, the insulation resistance, the capacitance, the residual current, and possibly the DAR, the PI, the DD, the resistance referred to the reference temperature, etc.

To exit without recording, press the ◀ key. You then return to the last measurement.

For each new record, the instrument proposes the first free memory location that follows the last record. It is also possible to record a measurement at a memory location that has already been used.

The bargraph indicates the quantity of memory used (in black), the quantity of memory available (in white).

MEMORY				
0		100%		
Obj. Test	Date	Time	Fct.	
03 01	2011-05-28	09:04	2550V	
02 02	2011-05-27	10:43		<input type="checkbox"/>
02 01	2011-05-27	10:38		<input type="checkbox"/>
01 02	2011-05-26	15:04	1000V	<input type="checkbox"/>
01 01	2011-05-26	14:56	500V	

The type of measurement and the availability of samples are indicated.

The number of measurements that can be recorded depends on the number of samples stored for each measurement.

The instrument can store 256 measurements. This number decreases if many samples are stored.

6.2. READING RECORDED VALUES

Set the switch to MR.

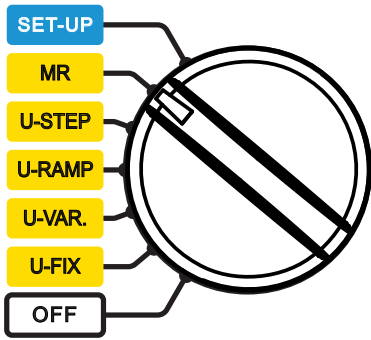

The instrument shows an overview of the object number usage and the object number of the last used record, along with the lowest and highest test numbers it contains.

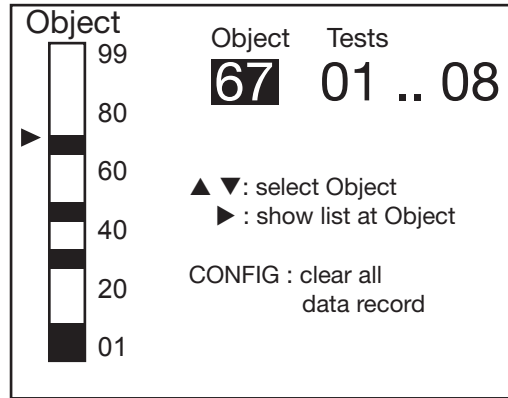

Choose the object number using the ▲▼ keys, then press the ► key.

The instrument then displays the list of records around the object chosen.

Obj. Test	Date	Time	Fct.
03 01	2011-05-28	09:04	2550V
► 02 02	2011-05-27	10:43	☒ ☑
02 01	2011-05-27	10:38	☒
01 02	2011-05-26	15:04	1000V ☑
01 01	2011-05-26	14:56	500V

To see details of a measurement, place the cursor on the object and the test chosen using the ▲▼ keys, then press the ► key.



Obj. Test	Date	Time	Fct.
02 02	2011-05-27	10:43	☒ ☑
Resistance			5.05 GΩ
Voltage			965 V
Current			190.6 nA
Elapsed time			00:01:40

Press the DISPLAY key to see the rest of the recorded information (depends on the currently function).





Obj. Test	Date	Time	Fct.
02 02	2011-05-27	10:43	☒ ☑
ΔR			--- TΩ
ΔV			--- V
ΔR/(R+ΔV) (ppm/V)			---
Capacitance			<1nF



Obj. Test	Date	Time	Fct.
02 02	2011-05-27	10:43	☒ ☑
Step Function			
Step	Voltage	Duration (m:s)	
1	100 V	0:30	
2	200 V	0:30	
3	300 V	0:30	
4	400 V	0:30	
5	500 V	0:30	

When the  symbol indicates that the samples have been recorded, you can press the GRAPH key to view the curve.



Obj. Test	Date	Time	Fct.
02 02	2011-05-27	10:43	 
Step Function			
Step	Voltage	Duration (m:s)	
6	600 V	0:30	
7	700 V	0:30	
8	800 V	0:30	
9	900 V	0:30	
10	1000 V	0:30	

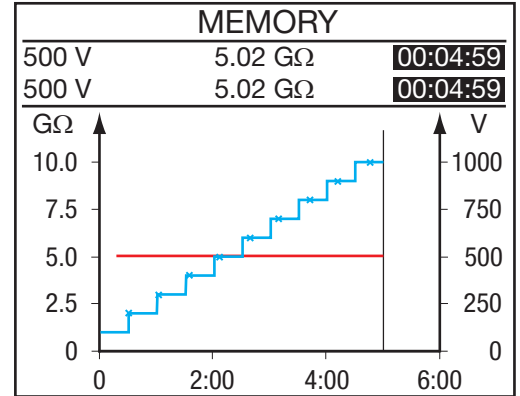

Press the GRAPH key to exit from the curve.
In the case of a U-FIXED or U-VAR measurement, you can press the TEMP key to view the information concerning the temperature.

The instrument can display only the information recorded with the measurement.



Obj. Test	Date	Time	Fct.
05 02	2011-05-27	10:43	2500V
Ambient Temperature			23 °C
Humidity			40%
Probe Temperature			23 °C
Rc Reference Temperature			40 °C
ΔT for R/2			10 °C
R measured			5.00 GΩ
Rc at 40 °C			1.529 GΩ



Press the TEMP key to exit from the temperature menu.



Press ◀ key to return to the list of recorded measurement.

6.3. ERASING THE MEMORY

Set the switch to MR.

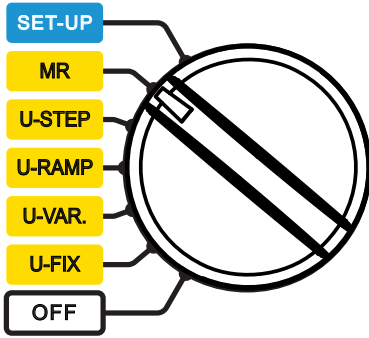

6.3.1. ERASING ONE RECORD

Use the ▲▼keys to select the record to be erased in the list of records in memory.

Obj. Test	Date	Time	Fct.
03 01	2011-05-28	09:04	2550V
▣ 02 02	2011-05-27	10:43	☒
02 01	2011-05-27	10:38	☒
01 02	2011-05-26	15:04	1000V ☒
01 01	2011-05-26	14:56	500V

Press the CONFIG key.
The instrument requests confirmation of the deletion.



MEMORY

! WARNING !

Selected data set
will be cleared !

O.K.

▣ **CANCEL**

Select OK to confirm or CANCEL to cancel. The instrument then returns to the memory read entry screen.

<p>Object</p> <p>99</p> <p>80</p> <p>60</p> <p>40</p> <p>20</p> <p>01</p>	<p>Object Tests</p> <p>67 01 .. 08</p>	<p>▲▼ : select Object</p> <p>▶ : show list at Object</p> <p>CONFIG : clear all data record</p>
---	---	--

6.3.2. ERASING ALL RECORDS

The instrument requests confirmation of the deletion. Select OK to confirm or CANCEL to cancel.

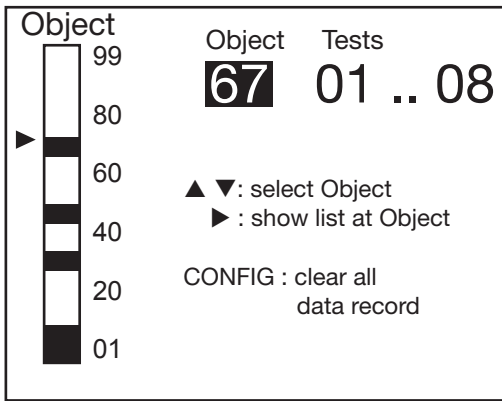

Press the CONFIG key.



The instrument in this case completely reformats the memory, which takes a few minutes. During this time, it displays WAIT.

The instrument then returns to the memory read entry screen. But since there is no longer any record, it displays:



6.4. LIST OF CODED ERRORS

If an anomaly is detected when the instrument is started up or in operation, the display indicates an error code. The format of this error code is a two-digit number. This number identifies the anomaly and states what to do to put the instrument back into service.

There are three types of error messages:

- **Informative error messages:**

The message appears for approximately 1 second. Depending on the error the functionality of the device may be reduced. A repair is needed if the error recurs.

Errors 04, 06, 07, 20, 21, 23, 30, 31, 32 (see also the second type of error), 40, 41, 42

Error 06 is preceded by an automatic reset.

Errors 04 and 07 are followed by error 06.

Error 20 indicates that a memory operation has failed.

Error 21 indicates that the settings have been automatically reset to default settings.

Error 23 indicates that the battery management is not available and no battery charging is possible.

Error 30 indicates that a resistance measurement has been stopped unexpectedly; check if there are any disturbances.

Errors 31, 32 (see also the second type of error) and 40 indicate that no measurement is possible.

- **Recoverable error messages:**

The message disappears if the rotary switch position is changed. Depending on the error the functionality of the device may be reduced. A repair is needed if the error recurs.

Errors 22, 32 (see also the first type of error)

Error 32 (see also the first type of error) indicates that no measurement is possible.

■ **Fatal error messages:**

No operation is possible. Power off the device and power it back on. A repair is needed if the error recurs.

Errors 01, 08, 09

In addition to error messages there are other indications for errors:

- If the device shows a cross on the screen when powered on and after a few seconds additionally a horizontal bar on the top of the screen, this indicates that language data is needed.
Use the PC program from our web site (see §9.2) to upload language data.
- If instead of information on the help screen just the headline "HELP" and below the number 98 or 99 is shown, this indicates that language data for help is needed.
Use the PC program from our web site (see §9.2) to upload language data.

7. DATA TRANSFER SOFTWARE

DataView®, the data transfer software supplied with the instrument, can be used to export the measurements and to present them in the form of a report.

Start by installing the software using the CD supplied with the instrument.

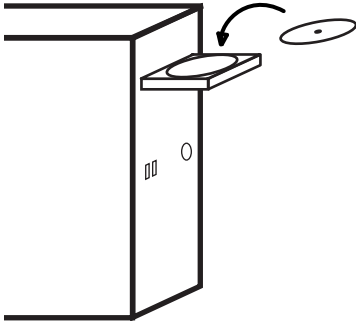

Set the switch to any position other than OFF.
The data rate must be 38,400 bauds for the instrument (see §5.2) and for the PC.

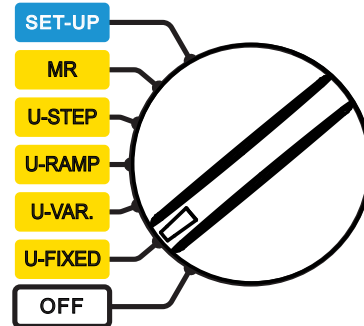

Then connect the instrument to the PC using the optical-USB cord supplied with the instrument, after removing the cover that protects the port in the instrument.

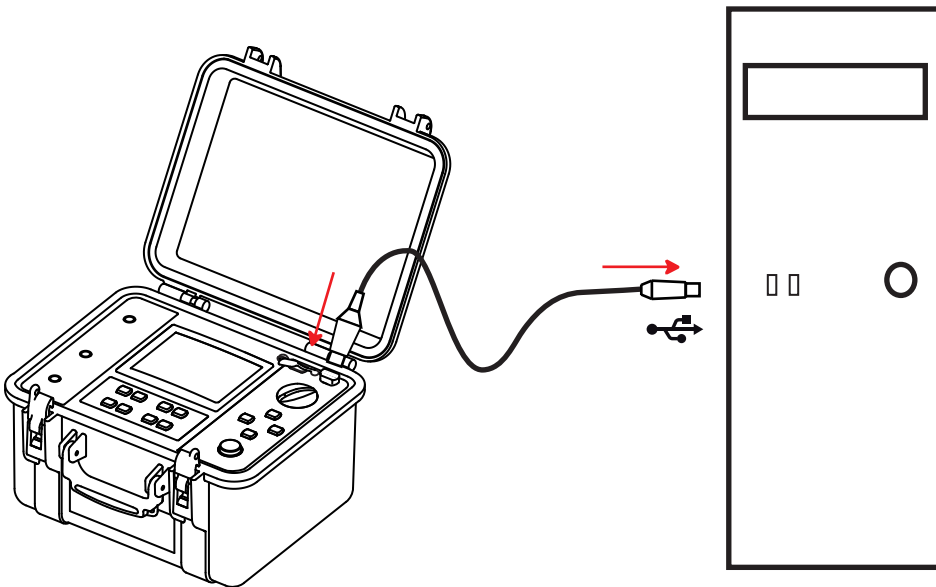

When in communication with a PC, the instrument displays REMOTE and no longer reacts to the user's commands. The keys and the rotary switch are inactive, except for stopping the instrument (OFF setting).
To use the data transfer software, refer to the on-line help.

REMOTE	
ADJUSTABLE VOLTAGE 1	
50 V	
Input voltage	0.1 V AC
Frequency	0.2 Hz
Input current	11 pA
Date 2011.05.24	Time 15:31

Once the data transfer is over, you can disconnect the instrument, then disconnect the cord. The instrument then resumes its normal operation.

8. SPECIFICATIONS

8.1. REFERENCE CONDITIONS

Influence quantities	Reference values
Temperature	23 ± 3°C
Relative humidity	45 to 55% RH
Supply voltage	9 to 12V
Frequency range	DC and 15.3 ... 65Hz
Capacitance in parallel on resistance	0µF
Electric field	null
Magnetic field	<40A/m

The **intrinsic uncertainty** is the error specified for the reference conditions.

The **operating uncertainty** includes the intrinsic uncertainty plus variations of the quantities of influence (supply voltage, temperature, interference, etc.) as defined in standard IEC-61557.

8.2. CHARACTERISTICS PER FUNCTION

8.2.1. VOLTAGE

■ Characteristics

Measurement range	1.0 ... 99.9V	100 ... 999V	1000 ... 2500V	2501 ... 4000V
Resolution	0.1V	1V	2V	2V
Intrinsic uncertainty	±(1% +5 pt)	±(1% +1 pt)		
Frequency range	DC or 15 ... 500 Hz			DC

■ **Input impedance:** 3MΩ

8.2.2. CURRENT

Specified measurement range (DC)	0.000 ... 0.399 nA	0.400 ... 3.999 nA	4.00 ... 39.99 nA	40.0 ... 399.9 nA	400 nA ... 3.999 µA
Resolution	1 pA	1 pA	10 pA	100 pA	1 nA
Intrinsic uncertainty	±(15% + 10 pt)	±10%	±5%		

Specified measurement range (DC)	4.00 ... 39.99 µA	40.0 ... 399.9 µA	400 µA ... 3.999 mA	4.00 ... 9.999 mA
Resolution	10 nA	100 nA	1 µA	10 µA
Intrinsic uncertainty	±5%			

8.2.3. INSULATION RESISTANCE

■ **Method:** Voltage-current measurement per IEC-61557-2 from 300 to 10,000V and per DIN VDE 0413 Part 1/09.80).

■ **Nominal output voltage:** 500, 1000, 2,500, 5000, 10000, and 15000V_{DC} for the C.A. 6555
 or adjustable from 40 to 10,000V_{DC} and 15,000V_{DC} for the C.A. 6555
 Intrinsic uncertainty ±1%
 adjustable from 40 to 1,000V_{DC} in 10-V steps
 adjustable from 1000 to 15,000V_{DC} in 100-V steps

- **Maximum current:** $\leq 1\text{mA}_{DC}$ from 40 to 999V
5 to 0.2mA_{DC} from 1000 to 15000V. The user can adjust this current.
- **Maximum acceptable peak AC voltage on the terminals during measurement:** $0,4 U_N$ or 1000 V_{AC} maximum.
- **Short-circuit current:** $\leq 5\text{mA}_{DC} \pm 5\%$. This current can be limited in SET-UP (parameter: Maximum output current), to between 0.2 and 5mA. It can also be limited by the maximum output power, which is 10W.
- **Maximum output current as a function of the test voltage**

U_N (V)	50	100	200	300	1100	1200	1300	5000	10000	15000
I (mA)	0.22	0.46	0.93	1.07	1.07	5	5	2	1	0.5
P (W)	≤ 1					10				

If the current is limited in SET-UP, the values mentioned above that exceed the limit will be lowered.

■ Fixed test voltage

Test voltage (V)	500 - 1000 - 2500 - 5000 - 10000 – 15000				
Specified measurement range	10 ... 999 k Ω 1.000 ... 3.999 M Ω	4.00 ... 39.99 M Ω	40.0 ... 399.9 M Ω	400 ... 3.999 G Ω	4.00 ... 39.99 G Ω
Resolution	1 k Ω	10 k Ω	100 k Ω	1 M Ω	10 M Ω
Intrinsic uncertainty	$\pm(5\% + 3 \text{ pt})$				
Operating error	$\pm(10\% + 6 \text{ pt})$				

Test voltage (V)	500 - 1000 - 2500 - 5000 10000 – 15000		≥ 1000	≥ 2500	≥ 5000
Specified measurement range	40.0 ... 399.9 G Ω	400 ... 999 G Ω 1.000 ... 1.999 T Ω	2.000 ... 3.999 T Ω	4.00 ... 10.00 T Ω	4.00 ... 15.00 T Ω
Resolution	100 M Ω	1 G Ω	1 G Ω	10 G Ω	10 G Ω
Intrinsic uncertainty	$\pm(15\% + 10 \text{ pt})$				$\pm(20\% + 10 \text{ pt})$
Operating error	$\pm(20\% + 15 \text{ pt})$	$\pm(30\% + 15 \text{ pt})$			

Test voltage (V)	≥ 10000	15000 (C.A.6555 only)
Specified measurement range	4.00 ... 25.00 T Ω	4.00 ... 29.00 T Ω
Resolution	10 G Ω	10 G Ω
Intrinsic uncertainty	$\pm(20\% + 10 \text{ pt})$	$\pm(20\% + 10 \text{ pt})$
Operating error	$\pm(30\% + 15 \text{ pt})$	

■ Variable test voltage

Minimum resistance measured = 10k Ω

Maximum resistance measured = to be interpolated from the values in the tables of fixed test voltages above.

The intrinsic uncertainty depends on the test voltage and on the resistance measured. It can be interpolated from the tables of fixed test voltages.

■ **Measurement of the DC voltage during the insulation test**

Input impedance: 3MΩ up to 1,600V and 300MΩ thereafter.

Specified measurement range (V)	40.0 ... 99.9	100 ... 1500	1600 ... 5100	5100 ... 16000
Resolution	0.1V	1V	1-2V	2-4V
Intrinsic uncertainty	±1%			

■ **Measurement of the DC voltage during the discharging stage of the insulation test**

Specified measurement range (Vdc)	25 ... 16000V
Resolution	0.2% Un
Intrinsic uncertainty	±(5% ± 3 pt)

■ **Typical discharge time of a capacitive element to reach 25Vdc**

Test voltage	50V	100V	250V	500V	1000V	2500V
Discharge time (C at μF)	0.25 s x C	0.5 s x C	1 s x C	2 s x C	4 s x C	7 s x C

Test voltage	5000V	10000 V	15000V
Discharge time (C at μF)	14 s x C	27 s x C	57 s x C

■ **Typical curves of evolution of the test voltages on the terminals of the instrument as a function of the resistance.**

500V range

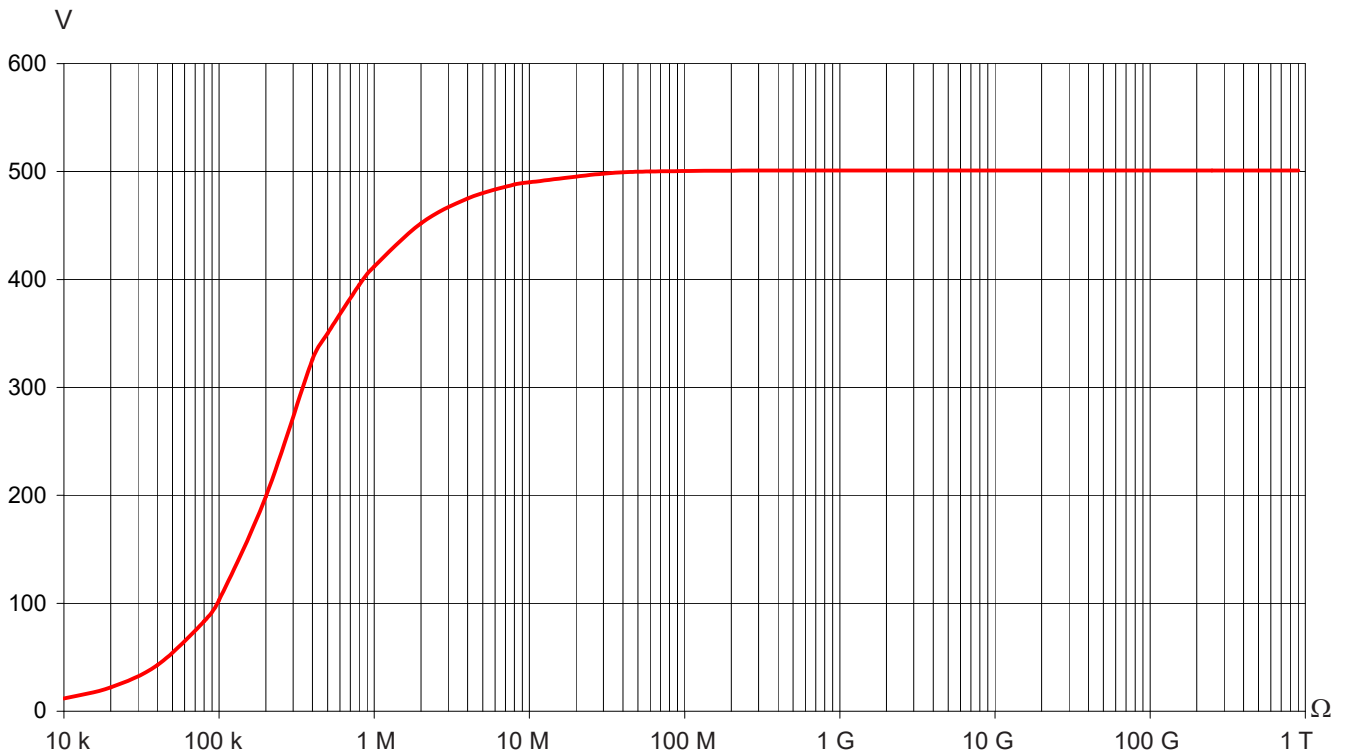

1000V range

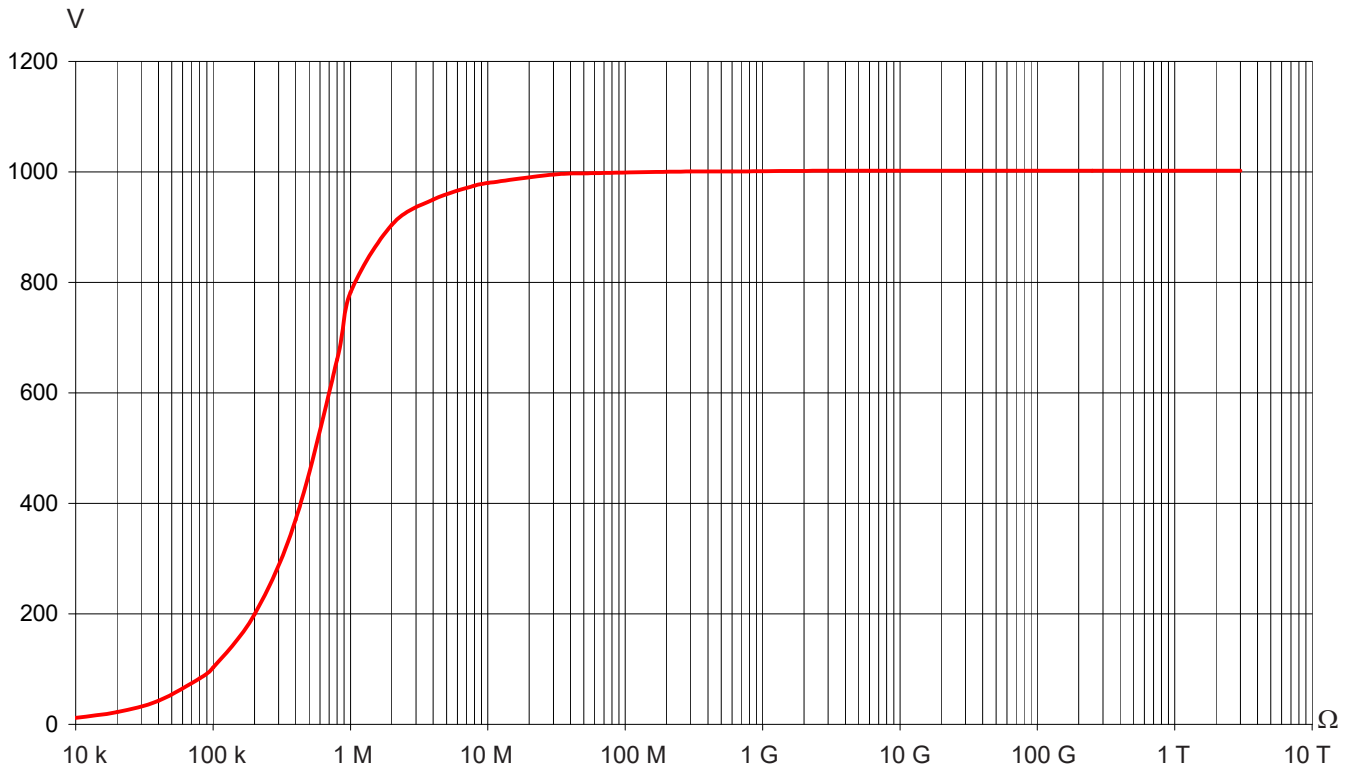

2500V range

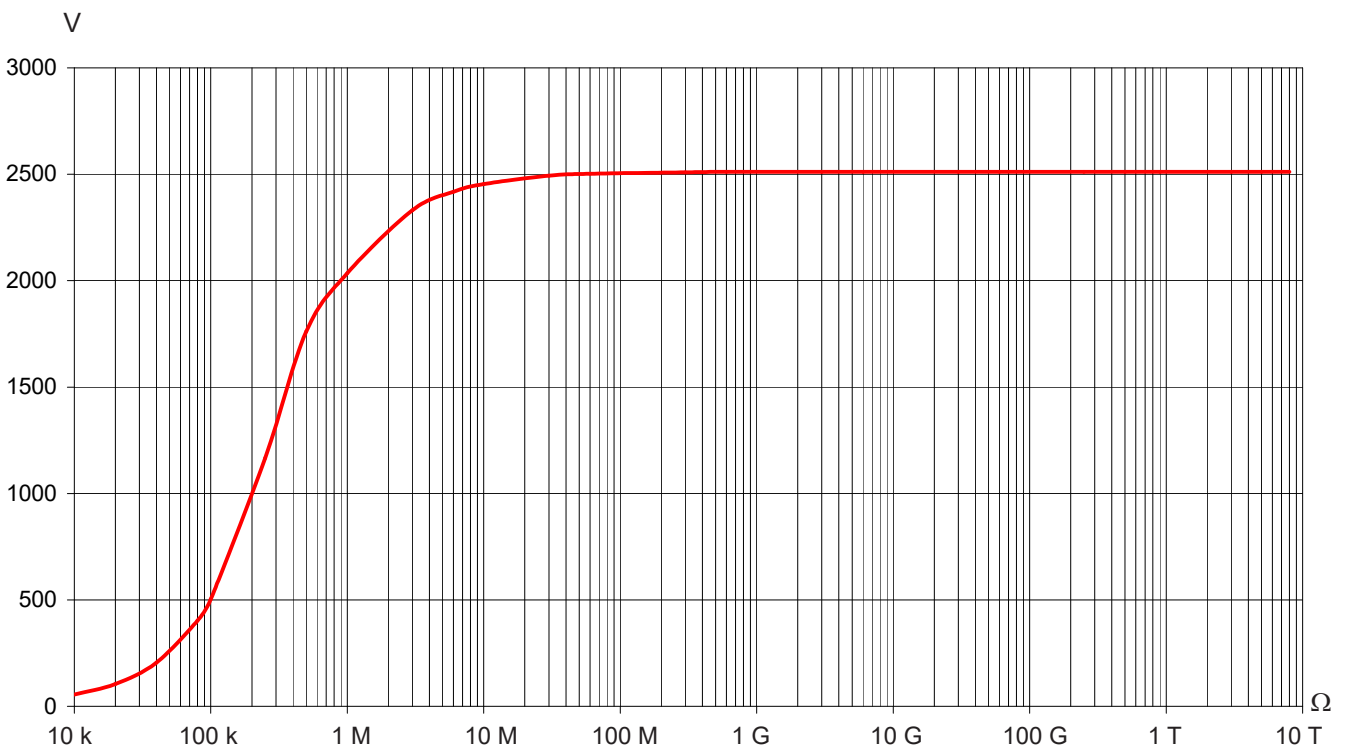

5000V range

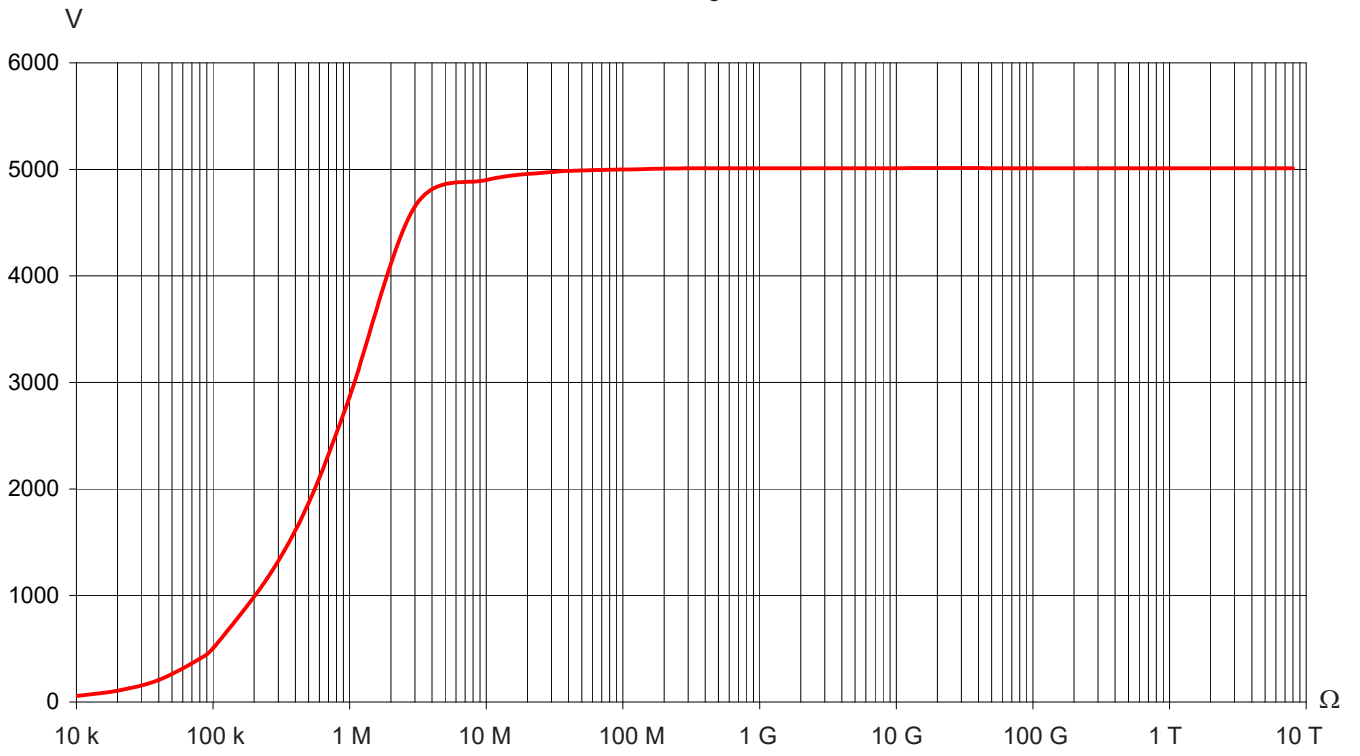

10000V range

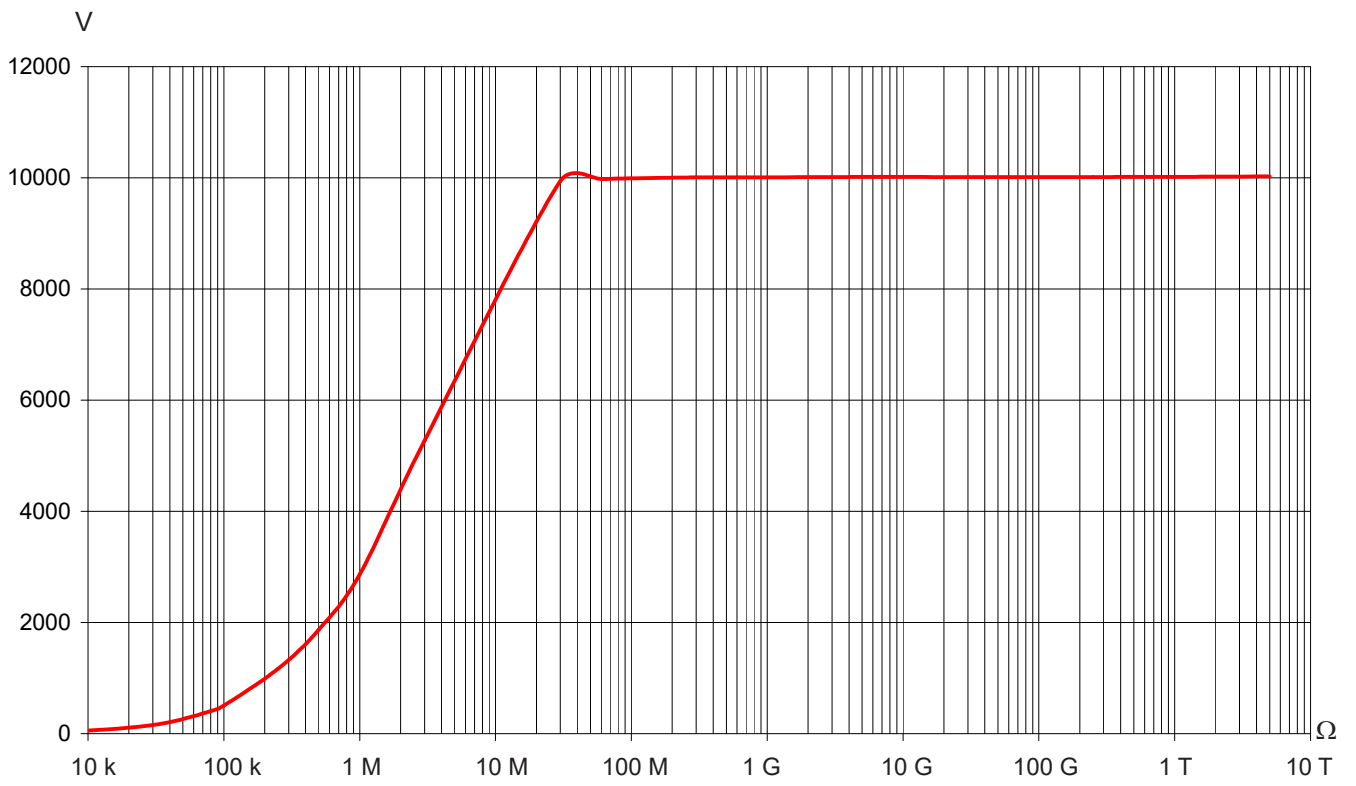

15000V range

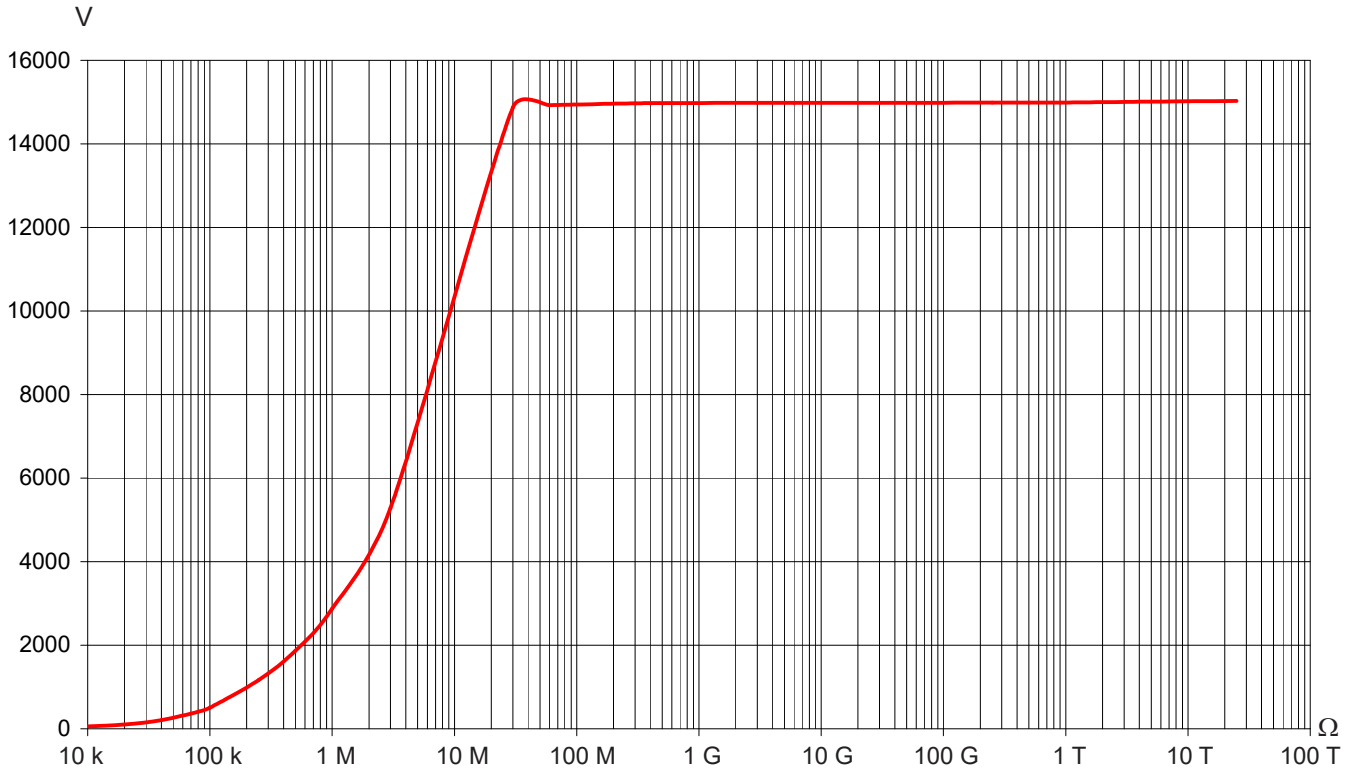

8.2.4. DAR, PI, AND DD

■ Calculation of the DAR and PI terms

Specified range	0.02 ... 50.00
Resolution	0.01
Intrinsic uncertainty	± (5% + 1 pt)

■ Calculation of the DD term

Specified range	0.02 ... 50.00
Resolution	0.01
Intrinsic uncertainty	± (10% + 1 pt)

8.2.5. CAPACITANCE

Capacitance measurement

This measurement is made following the discharging of the element tested, after each measurement

Specified measurement range	0.005 ... 9.999µF	10.00 ... 19.99µF
Resolution	1 nF	10 nF
Intrinsic uncertainty *	± (10% + 1 pt)	± 10%

*: this uncertainty is specified only for a test voltage ≥500V.

8.3. POWER SUPPLY

Power supply to the instrument is from two rechargeable 9.6V, 4Ah NiMH battery packs.

Charging is carried out by connecting the instrument to mains, at a voltage of 90 to 260V and a frequency of 50-60Hz, with an ambient temperature of 0 to 30°C.

8.3.1. NIMH TECHNOLOGY

The NiMH technology has many advantages, such as:

- long life between charges with limited bulk and weight,
- the possibility of recharging your battery rapidly,
- a very small memory effect: you can recharge your battery even if it is not fully discharged, without reducing its capacity,
- protection of the environment through the absence of polluting materials such as lead and cadmium.

The NiMH technology allows a limited number of charging/discharging cycles that depends on the conditions of use and the charging conditions. Under optimum conditions, this number of cycles is 200.

8.3.2. BATTERY CHARGING

The built-in charger manages the charging current, the battery voltage, and the internal temperature of the battery simultaneously. This optimizes the charging, while ensuring a long battery life.

The day before you use your device, check its charge condition. If the battery level indicator shows less than three bars, charge the device overnight (see §1.5).

The charging time varies between 6h and 10h.

A half-hour charge restores 10% of the capacity of the battery, enough to make a few measurements.

It is possible to recharge the batteries while making insulation measurements, provided that the voltages used are not too high and the measured resistances are high enough. In this case, the recharging time will exceed 6 hours. If the power necessary for the measurement approaches 10 W, the batteries are no longer charging.

In order to extend the life of your battery:

- Charge your device only between 10 and 30°C.
- Observe the conditions of use and storage stated in this data sheet.

A new battery becomes fully effective only after several complete charging/discharging cycles. This will not however prevent you from using your device when it has been charged for the first time. However, we recommend making the first charge a full charge (at least 10 hours).

If the instrument indicates that charging is over, do not hesitate to disconnect the charger for a few seconds, then reconnect it to top up the charge.

The battery in your instrument, like any rechargeable battery, is subject to significant residual discharging, even when the instrument is off. If your device has not been used for several weeks, it is probable that the battery will be partially discharged, even if it had been fully recharged just before going into storage.

In this case, before using it again, you should fully recharge the battery (at least 10 hours).

The longer your battery is stored, the more it is discharged. After three months' storage of the battery without periodic recharging, the battery is probably fully discharged.

Possible consequences are:

- Failure of the instrument to switch on, as long as the mains cord is not connected.
- A loss of the instrument's date and time (it reverts to 1 January 2010).

8.3.3. OPTIMIZE BATTERY CHARGING

During charging, the temperature of the battery rises substantially, especially towards the end. A safety device, built into the battery, checks constantly that the battery temperature does not exceed an acceptable maximum. If this maximum is exceeded, the charger switches off automatically, even if charging is not complete.

Above 30°C, it is not possible to charge the battery fully because the charging will cause overheating.

8.3.4. LIFE BETWEEN CHARGES

The mean battery life depends on the measurement and on how the device is used.

Test voltage (V)	500	1 000	2 500	5 000	10 000	15 000	Voltmeter
Battery life (h)	15	12	2	2	2	2	25

How long your device can operate when the battery is fully charged depends on several factors:

- The consumption of the device, which depends on the measurements you make,
- The capacity of the battery. It is greatest when the battery is new, and declines as the battery ages.

Here are a few ways to extend battery life between charges,:

- Use the back-lighting only when it is strictly necessary,
- Set the brightness of the back-lighting to the lowest level at which you can still read the display unit,
- Program an automatic switching off time (see SET-UP, § 5.2),
- During insulation measurements made in MANUAL mode, with high test voltages, stop the measurement by pressing the START/STOP button as soon as the needed measurement time is over.

8.3.5. “DEFECT” MESSAGE

When a battery is deeply discharged or its storage temperature is low, the charger may execute a reactivation stage prior to charging. That means that the charger applies a slow charge until the battery reaches either a minimum temperature threshold or a minimum charge voltage threshold.

If the battery is in good condition, this reactivation stage ends after about 45 mins and the charger switches over to fast charging.

However, if the maximum time allowed for the reactivation stage is exceeded or the internal resistance of a battery at the end of its life is high, the instrument declares the battery defective in the form of a message (Defect) on the screen of the measuring instrument.

The instrument must then be sent in for repair.

8.4. ENVIRONMENTAL CONDITIONS

- **Range of use**
The relative humidity can significantly affect insulation. Take care not to make an insulation resistance measurement if the temperature is below the dew point.
0 to 45°C, 0 to 90%RH
- **Specified domain of use**
0 to 35°C, 0 to 75%RH
- **Storage (without the batteries)**
-40 to 70°C, 10 to 90%RH
- **Altitude:** <2000 m
- **Degree of pollution:** 2

8.5. CONSTRUCTION SPECIFICATION

- Overall dimensions of the instrument (LxWxH): 340 x 300 x 200mm
- Weight: approximately 6.2kg

8.6. COMPLIANCE WITH INTERNATIONAL STANDARDS

- Electrical safety per: IEC-61010-1, IEC-61557 parts 1 and 2 (up to 10 kV) or VDE 0413.
- Double insulation
- Degree of pollution: 2
- Voltage measurement category: 1.000V Cat. IV.
- Maximum voltage with respect to earth: 1,000Vrms Cat IV.
- Maximum voltage between guard terminal G and the - terminal: 30Vrms.

8.6.1. ELECTROMAGNETIC COMPATIBILITY

Emissions and immunity in an industrial environment per IEC-61326-1.

8.6.2. MECHANICAL PROTECTIONS

- IP 65 according to IEC-60529 with the housing closed and IP 54 with the housing open.
- IK 04 according to IEC-50102.

8.7. VARIATIONS IN THE DOMAIN OF USE

Influence quantity	Range of influence	Quantity influenced ⁽¹⁾	Influence	
			Typical	Maximum
Battery voltage	9 ... 12V	V MΩ	< 1 pt < 1 pt	2 pt 3 pt
Temperature	-10 ... +55°C	V MΩ - GΩ U > 7.5 kV and R < 10 TΩ	±0.15%/10°C ±0.2%/10°C ±1.5%/10°C	±(0,3%/10°C + 1 pt) ±(1%/10°C + 2 pt) ±(3%/10°C + 2 pt)
Humidity	10 ... 75%RH with t ≤ 35 °C	V MΩ (10 kΩ ... 40 GΩ) MΩ (40 GΩ ... 10 TΩ) U > 7.5 kV and 3 TΩ < R < 10 TΩ	±0.2% ±0.2% ±0.3% ±(15% + 5 pt)	±(1% + 2 pt) ±(1% + 5 pt) ±(15% + 5 pt) ±(30% + 5 pt)
Frequency	15 ... 500 Hz	V	±3%	±(0.5% + 1 pt)
AC voltage superimposed on test voltage	0 ... 20%Un	MΩ	±0.1%/Un	±(0.5%/Un + 5 pt)

(1): The DAR, PI and DD terms and the capacitance and leakage current measurements are included in the quantity "MΩ".

8.8. INTRINSIC UNCERTAINTY AND OPERATING UNCERTAINTY

C.A 6550 and C.A 6555 megohmmeters comply with standard IEC-61557, which requires that the operating uncertainty, called B, be less than 30%.

In insulation measurements, $B = \pm (|A| + 1,15 \sqrt{E_1^2 + E_2^2 + E_3^2})$

with A = intrinsic uncertainty

E_1 = influence of the reference position ±90°.

E_2 = influence of the supply voltage within the limits indicated by the manufacturer.

E_3 = influence of the temperature between 0 and 35°C.

9. MAINTENANCE

The instrument contains no parts that can be replaced by personnel who have not been specially trained and accredited. Any unauthorized repair or replacement of a part by an “equivalent” may gravely impair safety.

9.1. MAINTENANCE

9.1.1. CLEANING

Disconnect the unit completely and turn the rotary switch to OFF.

Use a soft cloth, dampened with soapy water. Rinse with a damp cloth and dry rapidly with a dry cloth or forced air. Do not use alcohol, solvents, or hydrocarbons.

9.1.2. REPLACING THE BATTERIES

The batteries can be replaced only by competent, accredited personnel.

Warning : Back up all your stored data before sending the instrument in for repair.

When the repaired instrument is returned:

- Erase the memory completely (see §6.3.2) to be able to use the MEM/MR functions again.
- If necessary, reset the date and time of the instrument (see § 5).
- Fully recharge the battery.

9.1.3. REPLACING THE FUSE

If the GUARD FUSE message appears on the display unit, the guard terminal fuse must be replaced.

The fuse can be replaced only by competent, accredited personnel.

9.1.4. STORAGE

If the instrument has not been used over a prolonged period (more than two months) fully charge the battery before use.

9.2. UPDATING OF THE INTERNAL SOFTWARE

With a view to providing, at all times, the best possible service in terms of performance and technical upgrades, Chauvin Arnoux invites you to update the embedded software of the device by downloading the new version, available free of charge on our web site.

Our site:

www.chauvin-arnoux.com

Click on “Support”, then “Access the download area”, then enter the name of the instrument “C.A 6550 and C.A 6555”.

Connect the device to your PC using the USB cord provided.

The update of the embedded software depends on its compatibility with the hardware version of the instrument. This version is indicated in SET-UP (see §5).

Attention: updating the embedded software may reset the configuration and cause the loss of the stored data. As a precaution, save the stored data to a PC before updating the embedded software.

9.3. LIST OF PARAMETERS

Menu / screen	Setting	Range	Default	Reset to default by
Set-up	Buzzer	Off, 1, 2, 3	1	user
Set-up	Power Down	Off, On	Off	user
Set-up	Baud Rate	9600, 19200, 38400, 57600	38400	user
Set-up	Temperature Unit	Celsius, Fahrenheit	Celsius	user
Set-up, Config	Timed Run (m:s)	0:01 ... 99:59	2:00	user
Set-up, Config	DAR (s/s)	10/15 ... 90/180	30/60	user
Set-up, Config	PI (m/m)	0.5/1.0 ... 30/90	1.0/10	user
Set-up, Config	Test Type	Burn-in, Early-Break, Break at I-limit	Burn-in	user
Set-up, Config	Maximum Output Current (if not Early-Break)	0.2mA ... 5mA	5mA	user
Set-up, Config	Maximum Output Current (if Early-Break)	0.2mA	0.2mA	
Set-up	Maximum Output Voltage	40V ... 15000V	C.A 6550: 10000 V C.A 6555: 15000 V	user
Set-up	Adjustable Voltage 1	40V ... 15000V	50V	user
Set-up	Adjustable Voltage 2	40V ... 15000V	800V	user
Set-up	Adjustable Voltage 3	40V ... 15000V	7000V	user
Set-up, Config	Step Function 1 - Voltages	40V ... 15000V	50V, 100V, 150V, 200V, 250V, 300V, 350V, 400V, 450V, 500V	user
Set-up, Config	Step Function 1 - Durations (m:s)	0:00 ... 99:59 (sum of all 10 steps)	all 0:30 (sum is 5:00)	user
Set-up, Config	Step Function 2 - Voltages	40V ... 15000V	500V, 1000V, 1500V, 2000V, 2500V, 3000V, 3500V, 4000V, 4500V, 5000V	user
Set-up, Config	Step Function 2 - Durations (m:s)	0:00 ... 99:59 (sum of all 10 steps)	all 0:30 (sum is 5:00)	user
Set-up, Config	Step Function 3 - Voltages	40V ... 15000V	1000V, 2000V, 3000V, 4000V, 5000V, 6000V, 7000V, 8000V, 9000V, 10000V	user
Set-up, Config	Step Function 3 - Durations (m:s)	0:00 ... 99:59 (sum of all 10 steps)	all 0:30 (sum is 5:00)	user
Set-up, Config	Ramp Function 1 - Voltages	40V ... 15000V	50V, 500V	user
Set-up, Config	Ramp Function 1 - Start Step Duration (m:s)	0:30 ... 99:39 (sum of all 3 steps)	0:30	user
Set-up, Config	Ramp Function 1 - Ramp Step Duration (m:s)	0:10 ... 99:19 (sum of all 3 steps)	2:00	user
Set-up, Config	Ramp Function 1 - End Step Duration (m:s)	0:10 ... 99:19 (sum of all 3 steps)	0:30	user
Set-up, Config	Ramp Function 2 - Voltages	40V ... 15000V	500V, 5000V	user
Set-up, Config	Ramp Function 2 - Start Step Duration (m:s)	0:30 ... 99:39 (sum of all 3 steps)	0:30	user
Set-up, Config	Ramp Function 2 - Ramp Step Duration (m:s)	0:10 ... 99:19 (sum of all 3 steps)	2:00	user

Menu / screen	Setting	Range	Default	Reset to default by
Set-up, Config	Ramp Function 2 - End Step Duration (m:s)	0:10 ... 99:19 (sum of all 3 steps)	0:30	user
Set-up, Config	Ramp Function 3 - Voltages	40V ... 15000V	1000V, 10000V	user
Set-up, Config	Ramp Function 3 - Start Step Duration (m:s)	0:30 ... 99:39 (sum of all 3 steps)	0:30	user
Set-up, Config	Ramp Function 3 - Ramp Step Duration (m:s)	0:10 ... 99:19 (sum of all 3 steps)	2:00	user
Set-up, Config	Ramp Function 3 - End Step Duration (m:s)	0:10 ... 99:19 (sum of all 3 steps)	0:30	user
Set-up, Config	Alarm 500V	10 kΩ à 2 TΩ	500 kΩ	user
Set-up, Config	Alarm 1000V	10 kΩ à 4 TΩ	1 MΩ	user
Set-up, Config	Alarm 2500V	10 kΩ à 10 TΩ	2,5 MΩ	user
Set-up, Config	Alarm 5000V	10 kΩ à 16 TΩ	5 MΩ	user
Set-up, Config	Alarm 10000V	10 kΩ à 25 TΩ	10 MΩ	user
Set-up, Config	Alarm 15000V	10 kΩ à 30 TΩ	15 MΩ	user
Set-up, Config	Alarm Adjustable Voltage 1	10 kΩ ... depending on voltage	50 kΩ	user
Set-up, Config	Alarm Adjustable Voltage 2	10 kΩ ... depending on voltage	800 kΩ	user
Set-up, Config	Alarm Adjustable Voltage 3	10 kΩ ... depending on voltage	7 MΩ	user
Config	Measurement Mode	Manual Stop Manual Stop + DD Timed Run Timed Run + DD DAR PI	Manual Stop	user
Config	I-Range	Auto, 300nA, 50μA, 7mA	Auto	power off
Config	Disturbance Level	Low, High	Low	power off
Temperature	Ambient Temperature	-15°C ... 75°C or 6°F ... 167°F	23	user
Temperature	Humidity	0% ... 100%	40	user
Temperature	Probe Temperature	-15°C ... 75°C or 6°F ... 167°F	23	user
Temperature	Rc Reference Temperature	-15°C ... 75°C or 6°F ... 167°F	40	user
Temperature	ΔT for R/2	-15°C ... 75°C or 6°F ... 167°F	10	user
Contrast & Backlight	Display Contrast	0 ... 25	10	user
Contrast & Backlight	Backlight	0 ... 5	0	user
Memory	Store Samples	No, Yes	Yes	user
Memory	Sample Time (m:s)	Auto, Min., 0:01 ... 0:25	Min.	user
Measurement	Filter	Auto, Off, 10s, 20s, 40s	Auto	power off
Measurement	Alarm	Off, On	Off	entering function, other than U-FIX or U-VAR

10. WARRANTY

Except as otherwise stated, our warranty is valid for **24 months** starting from the date on which the equipment was sold. Extract from our General Conditions of Sale provided on request.

The warranty does not apply in the following cases:

- Inappropriate use of the equipment or use with incompatible equipment;
- Modifications made to the equipment without the explicit permission of the manufacturer's technical staff;
- Work done on the device by a person not approved by the manufacturer;
- Adaptation to a particular application not anticipated in the definition of the equipment or not indicated in the user's manual;
- Damage caused by shocks, falls, or floods.

FRANCE

Chauvin Arnoux Group

190, rue Championnet

75876 PARIS Cedex 18

Tél : +33 1 44 85 44 85

Fax : +33 1 46 27 73 89

info@chauvin-arnoux.com

www.chauvin-arnoux.com

INTERNATIONAL

Chauvin Arnoux Group

Tél : +33 1 44 85 44 38

Fax : +33 1 46 27 95 69

Our international contacts

www.chauvin-arnoux.com/contacts

