



IDEAL NETWORKS

# LanTEK<sup>®</sup> III



## **COPYRIGHT NOTICE**

The information contained in this document is the property of IDEAL INDUSTRIES Ltd. and is supplied without liability for errors and omissions. No part of this document may be reproduced or used except as authorized by contract or other written permission from IDEAL INDUSTRIES Ltd. The copyright and all restrictions on reproduction and use apply to all media in which this information may be placed.

IDEAL INDUSTRIES Ltd. pursues a policy of continual product improvement and reserves the right to alter without notice the specification, design, price or conditions of supply of any product or service.

**© IDEAL INDUSTRIES LTD. 2015**

All rights reserved

Publication ref: 161809

Issue 1 - 11/2015

(Applies to software revision 3.050 onwards)

IDEAL INDUSTRIES LTD.  
Stokenchurch House  
Oxford Road  
Stokenchurch  
High Wycombe  
Buckinghamshire  
HP14 3SX UK

[www.idealnetworks.net](http://www.idealnetworks.net)



## Safety Precautions

Exercise caution when handling rechargeable batteries (accumulators)

All lithium-ion battery packs (Li-ion), regardless of their indicated charge state, are capable of producing electrical current sufficient to cause personal injury and/or property damage.

Do not dispose of lithium-ion battery packs (Li-ion) in a fire or with regular waste. Lithium-ion battery packs (Li-ion) may explode if exposed to open flame. The battery packs are hazardous waste and may contaminate ground water sources if disposed of in landfills.

IDEAL INDUSTRIES, LTD. tries to provide the maximum protection possible by installing an automatic reset fuse in the battery packs, to help stop high current discharge as quickly as possible. However, these fuses may not completely protect against a momentary arc discharge, which can result if the battery pack's electrical contacts are shorted. The following battery pack handling precautions must be closely followed to avoid risk of injury.

- When a battery pack is not installed in the Display (DH) or Remote (RH) handset, it should be kept in a clean, dry, non-conductive package.
- Keep conductive materials away from the battery pack at all times.
- Keep contact sides of the battery pack away from each other at all times.
- Battery packs can be charged while in the Display (DH) and in the Remote (RH) handset, but also externally with the adapter. Charging in any other manner may cause the battery pack to explode.
- Always install, remove, store, and charge the battery packs in a non-explosive atmosphere.
- Observe operating and storage temperatures (see chapter 1.3. Dimensions, Weights, Operating Conditions).
- Do not allow children or persons unfamiliar with the precautionary instructions in this manual to handle or recharge the battery packs.
- Do not open the battery pack case. There are no user-serviceable parts inside the case, and the batteries in the case are not replaceable.



## Disclaimer

IDEAL INDUSTRIES, LTD. does not assume any liability for death, injury or damage to equipment or property resulting from improper use of the battery packs.

IDEAL INDUSTRIES, LTD. will not be liable for consequential damages that may result from tampering with the battery packs or charger or their use thereafter.

Subject to technical changes.

## Environmental Protection

If you have any questions concerning these precautions, the operating instructions, or any other concerns about the safe use and disposal of the battery packs used in LanTEK®III, please contact a representative of IDEAL INDUSTRIES, LTD. For contact information, please refer to Chapter Customer Service.

## Using the 161®III Cable Certifier

All cable parameter default settings programmed in the LanTEK®III Cable Certifier are based on generic standards, proposed industry recommendations for cables and network links, the latest technical information available from International LAN cabling standards committees, the LAN industry, and IDEAL INDUSTRIES' own experience and testing.

Before performing any measurements, IDEAL INDUSTRIES, LTD. recommends to request detailed information from contractor or project manager on the standards to be used for measuring, to ensure that relevant parameters are complied with.

## Information on the use of this Instruction Manual

The following symbols used in this manual indicate that the user should exercise particular caution in order to prevent personal injury or damage to the LanTEK®III Cable Certifier or the system under test.



### **WARNING!**

**This symbol indicates potentially lethal voltages. The life and/or health of the person performing the activity or anybody in the vicinity is at risk.**



### **CAUTION!**

**This symbol indicates that the relative activity could possibly harm the environment or damage technical equipment.**

### **NOTE:**

**Here you will find general notes, additional information, or support.**

## Typographical Conventions

- **Boldface** Refers to a button on LanTEK®III Cable Certifier.
- *Italics* Refers to a menu option in this Operating Manual.
- Quotation marks " " Identifies a "Screen Message".





CONTENTS

**Chapter 1. Your LanTEK III Cable Certifier ..... 6**

1.1 Technical Information.....6

1.2 Product Specifications.....7

1.3 Dimensions, Weights, Operating Conditions .....7

1.4 Performance Specifications.....8

**Chapter 2. Product Description ..... 9**

2.1 The Display Handset (DH).....9

2.1.1 Controls and Ports/Connectors.....9

2.1.2 TFT Display .....11

2.1.3 Function Keys F1 to F10 .....12

2.1.4 Soft Key.....12

2.2 The Remote Handset (RH).....13

2.2.1 Controls and Ports/Connectors.....13

2.3 Power Management.....15

2.3.1 Operating the Display and Remote handset from AC Power.....15

2.3.2 Battery Charging.....16

2.4 Talkset.....16

**Chapter 3. Basics of the Cable Test .....17**

3.1 Testing of cables and relevant requirements .....17

3.1.1 Setup for Permanent Link Test .....17

3.1.2 Setup for Channel Link Test .....18

3.1.3 Setup for other Test Methods.....18

**Chapter 4. Preferences.....19**

4.1 Open Preferences .....19

4.2 User Information.....19

4.3 Autotest Options.....20

4.4 Contrast.....21

4.5 Timeout Options.....21

4.6 Measurement Units.....22

4.7 Talkset.....22

4.8 Date and Time .....23

4.9 Restore Default .....24

4.10 Clear Memory.....24

4.11 Temperature.....25

**Chapter 5. Autotest ..... 26**

5.1 Set Autotest Pref.....27

5.2 Select Job Folder .....28

5.2.1 Enable Existing Job Folder.....28

5.2.2 Create New Job Folder .....29

5.3 Set Cable Name (cable ID).....30

5.3.1 Simple Cable ID.....31

5.3.2 Default Cable ID.....33

5.4 Labeling Standard TIA/EIA 606-A .....35

5.4.1 Cable Name in Format TIA/EIA 606A .....36

5.4.2 Cable Parameter 606A Drop .....36

5.4.3 Cable Parameter 606A Backbone .....37

5.4.4 Cable Parameter 606A Backbone Pair/Fiber .....37

5.5 Select Twisted Pair Cabling.....38

5.5.1 Specify Cable Type .....39

5.5.2 Create Cable Type.....39

5.5.3 Edit and Calculate NVP .....42

5.5.4 Enter Reference Temperature.....43

5.6 DualMODE™ Function for Twisted Pair Cabling.....44

5.6.1 Implement DualMODE™.....44

5.7 Edit NVP Default Value of a Cable .....46

5.8 Coaxial Cable Standards.....47



- 5.8.1 Autotest Test Series for Coaxial Cables..... 48
- 5.9 Calibration..... 48
  - 5.9.1 Twisted Pair Cabling..... 48
  - 5.9.2 Coaxial Cable ..... 50
- 5.10 Perform Autotest ..... 52
- 5.11 Open Job Folder of Autotest..... 52
  - 5.11.1 Job Options..... 53
  - 5.11.2 Test Options..... 54
  - 5.11.3 Copy Job Folder to USB Removable Storage..... 54
  - 5.11.4 Alien Crosstalk Measurements (AXT) ..... 54
- 5.12 Autotest Results and Graphs ..... 55
  - 5.12.1 Graph Formats, Layouts and Controls..... 56
- Chapter 6. Structured Cabling Testing ..... 58**
  - 6.1 Test Setup for Single Test Analysis..... 58
  - 6.2 Test Run of Single Test Analysis ..... 58
  - 6.3 Perform Single Test Analysis ..... 58
  - 6.4 Evaluation of Analysis Test Results..... 59
    - 6.4.1 Graphs for Analysis Tests..... 59
  - 6.5 Overview of Single Test Analysis..... 60
  - 6.6 Wiremap Test ..... 60
  - 6.7 Length Test..... 61
    - 6.7.1 Length Test Error ..... 61
  - 6.8 Resistance Test ..... 61
    - 6.8.1 Resistance Test Error ..... 62
  - 6.9 NEXT, ACR-F (ELFEXT) and Power Sum ..... 62
  - 6.10 Power Sum NEXT, Power Sum ACR-F (ELFEXT) ..... 63
    - 6.10.1 NEXT Test and ACR-F (Power Sum ELFEXT) Test Error ..... 64
  - 6.11 Insertion Loss Test (Attenuation)..... 64
    - 6.11.1 Insertion Loss test Error ..... 64
  - 6.12 Return Loss Test..... 64
    - 6.12.1 Return Loss Test Error..... 65
  - 6.13 Impedance Test ..... 65
    - 6.13.1 Impedance Error..... 65
  - 6.14 Delay and Skew Test ..... 66
    - 6.14.1 Delay and Skew Test Error ..... 66
  - 6.15 Capacitance Test..... 66
    - 6.15.1 Capacitance Test Error..... 67
  - 6.16 ACR-N (ACR) Test and Power Sum ACR-N (Power Sum ACR) Test..... 67
    - 6.16.1 ACR-N (ACR) Test and Power Sum ACR-N (Power Sum ACR) Test Error ..... 67
    - 6.16.2 Troubleshooting ACR-N (ACR) Test and Power Sum ACR-N (Power Sum ACR) Test Error ..... 67
  - 6.17 Headroom Test..... 67
    - 6.17.1 Headroom Test Error..... 68
  - 6.18 Custom Cable Preferences and Cable Parameters..... 68
    - 6.18.1 Creating a New Custom Cable Type..... 68
    - 6.18.2 Select Custom Cable Type..... 69
    - 6.18.3 Custom Cable Parameters..... 70
- Chapter 7. Coaxial Cable Test..... 71**
  - 7.1 Properties of Coaxial Cables ..... 71
  - 7.2 Troubleshooting Coaxial Cables..... 71
- Chapter 8. Tone Generator ..... 72**
  - 8.1.1 Enable Tone Generator with Display handset (DH)..... 72
  - 8.1.2 Enable Tone Generator with Remote handset (RH)..... 72
- Chapter 9. LanTEK Firmware Upgrade ..... 74**
  - 9.1 Perform Firmware Upgrade..... 74
    - 9.1.1 Using the Computer..... 74
    - 9.1.2 Firmware Upgrade with USB Removable Storage ..... 75
- Chapter 10. Customer Service ..... 76**



## Chapter 1. Your LanTEK III Cable Certifier

The LanTEK®III Cable Certifier is designed to measure twisted pair cables (TP), coaxial cables and fiber-optic cables used for high-speed data transmission in communications networks.

### 1.1 Technical Information

Features	LanTEK®III-500	LanTEK®III-1000
Frequency range	500 MHz	1000 MHz
Cable specification CAT 3/ISO C, CAT 5/ISO D, 5e/D new, 6/E	✓	✓
Cable specification CAT 6 <sub>A</sub> /ISO E <sub>A</sub>	✓	✓
Cable specification ISO F, ISO F <sub>A</sub>	Upgradeable	✓
Accuracy level III / IIIe / IV (LanTEK®III)	IIIe (ETL)	IIIe / IV (ETL)
DualMODE™-tests	✓	✓
Permanent Link test with patch cord for non RJ45 connectors	✓	✓
Permanent Link test with permanent link adaptor for RJ45 connectors	✓	✓
CAT 6 test storage capacity with graphs	1700	1700
USB port	✓	✓
Serial port (concerns only Service)	✓	✓
Fiber (LWL) loss and length measurement (FiberTEK™ FDX)	Optional	Optional
Communication over fiber (LWL) and copper (Full Duplex)	✓	✓
LCD-display on Remote handset (RH)	✓	✓
Tone generator to determine connection on near and remote end	✓	✓
Lithium-ion battery packs	✓	✓
Wireless connection to IDEAL AnyWARE™ app	✓ external dongle	✓ external dongle



## 1.2 Product Specifications

### Standard Test Compliance

ANSI/TIA/EIA 568A, 568B, 568-C2 CAT 6A/6/5E/3, ISO FA/F/EA/D/C, AS/NZS 3080, IEEE 802.3 Ethernet, EN50173 - FA/F/E/D/C

### Cable Types

UTP/SCTP/FTP CAT 3/5E/6A/7/7A (100  $\Omega$ ); Coax (50/75  $\Omega$ )

## 1.3 Dimensions, Weights, Operating Conditions

### Dimensions:

(L) 254 mm x (W) 127 mm x (D) 53 mm

### Weights:

Display handset (DH)	1180 g (incl. battery)
Remote handset (RH)	1120 g (incl. battery pack)
Battery pack	548 g

### Battery Packs Display Handset (DH) and Remote Handset (RH):

Lithium-ion battery packs (Li-ion)

### Operating life with Battery Pack:

18 hours under normal conditions

### Charging Time:

In handset	6-8 hours
External	4 hours

### Operating Temperature (min/max):

0° C to +50° C (Operate only if handset temperature is close to ambient temperature!)

### Storage Temperature (min/max):

-20° C to +70° C

### Relative Humidity:

5% to 90%, noncondensing



## 1.4 Performance Specifications

LanTEK®III	Range	Resolution	Accuracy
Length (50 - 100 Ω cable)	0 - 605 m	0.1 m	± (3 % + 1 m)
Delay	0 - 8000 ns	1 ns/0.1 m	± (3 % + 1 ns)
Average impedance	35 - 180	0,1	± (3 % + 1 )
Capacitance (bulk)	0 - 100 nF	1 pF or 3 digits	± (2 % + 20 pF)
Capacitance	0 - 333 pF/m	0.1 pF	± (2 % + 1 pF)
DC loop resistance	35 -200	0,1	± (1 % + 2 )
Attenuation	1 MHz - 1 GHz	0.1 dB	Level III/IIIe/IV
NEXT (crosstalk)	1 MHz - 1 GHz	0.1 dB	Level III/IIIe/IV
Return loss	1 MHz - 1 GHz	0.1 dB	Level III/IIIe/IV
ELFEXT / ACR-F	1 MHz - 1 GHz	0.1 dB	Level III/IIIe/IV
ACR / ACR-N	1 MHz - 1 GHz	0.1 dB	Level III/IIIe/IV



## Chapter 2. Product Description

### 2.1 The Display Handset (DH)

The Display handset (DH) ensures control of preferences and test functions during individual cable tests.

#### 2.1.1 Controls and Ports/Connectors

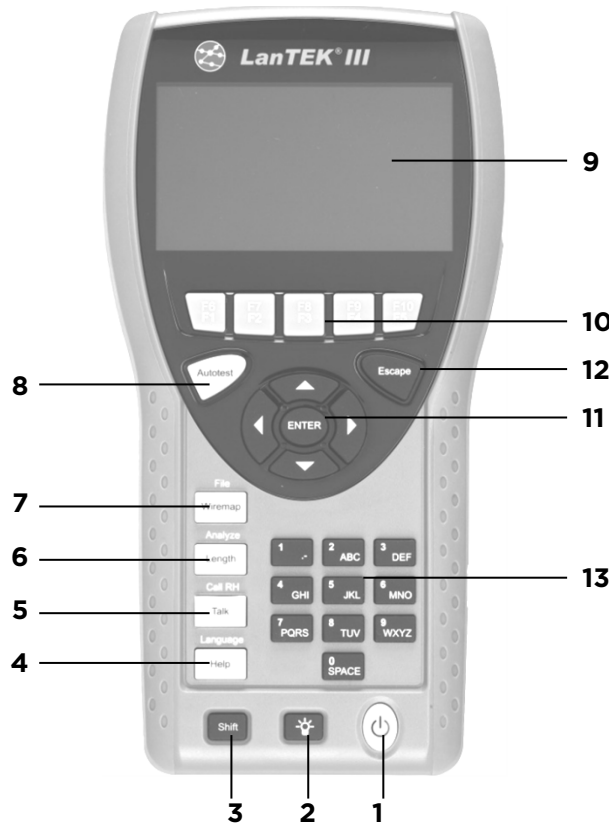
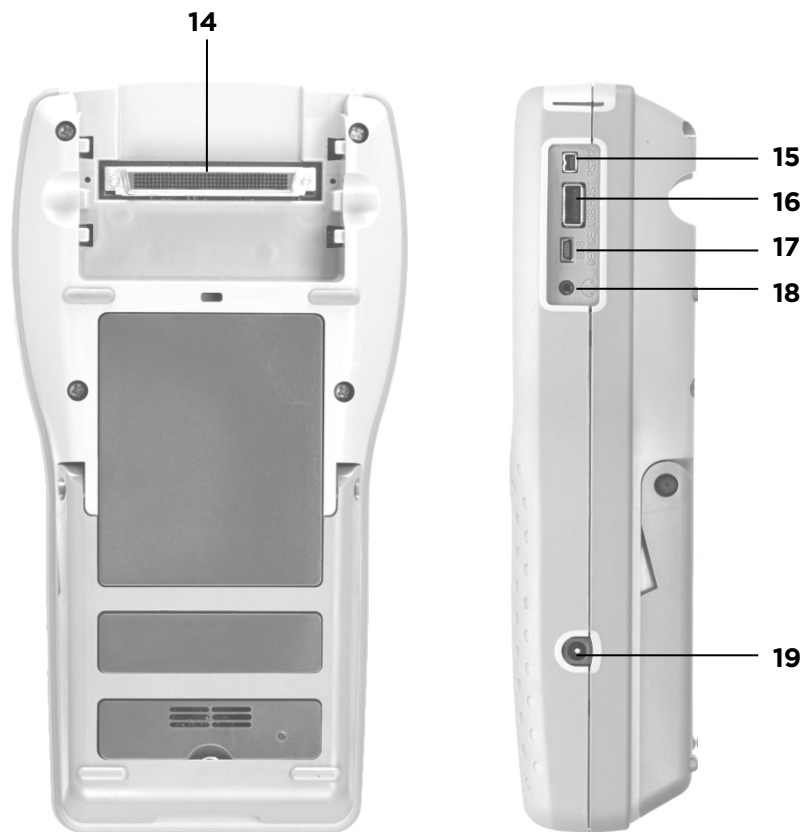

Fig. 1 The Display Handset (DH) Front view

	Controls	Description
1	On/Off	Power the Display handset (DH) on/off.
2	Dim Backlight	Dim Backlight in two stages.
3	Shift	Toggle key activities having dual functions.
4	Help / Language	Open Help Menu / Open Language Selection
5	Talk / Call RH	Activate Talkset function / call Remote Handset (RH).
6	Length / Analyze	Open Length Measurement / Open Diagnostics Menu.
7	Wiremap / File	Open analyze function "Wiremap" / Open Job List.



	<b>Controls</b>	<b>Description</b>
8	Autotest	Direct execution of test run pre-programmed for established standards.
9	TFT-Display	Display of menus, test results, graphs, activity selection and function keys.
10	Function keys F1 to F5 / F6 to F10	Select menu options displayed on screen.
11	Arrow Keys / Enter	Navigate menus on TFT Display / Enter key to activate and edit the selected menu.
12	Escape	Abort and exit the current menu without making changes.
13	Alphanumeric Keys	Enter numbers, letters and special characters.



**Fig. 2 The Display Handset (DH) Rear and side view**

	<b>Ports/Connectors</b>	<b>Description</b>
14	Low-NEXT-Connector	Connect a test adapter.
15	Service and Maintenance Jack	Connection for service and maintenance work.
16	USB Port	Connect USB removable devices to transmit data and to load Firmware-Updates.
17	USB Device	Connect to a computer
18	Talkset Jack	Connect a Talkset.
19	DC Input Jack	Connect an external power supply and charge battery pack.





### 2.1.2 TFT Display

Ready screen appears on operational Display handset (DH).

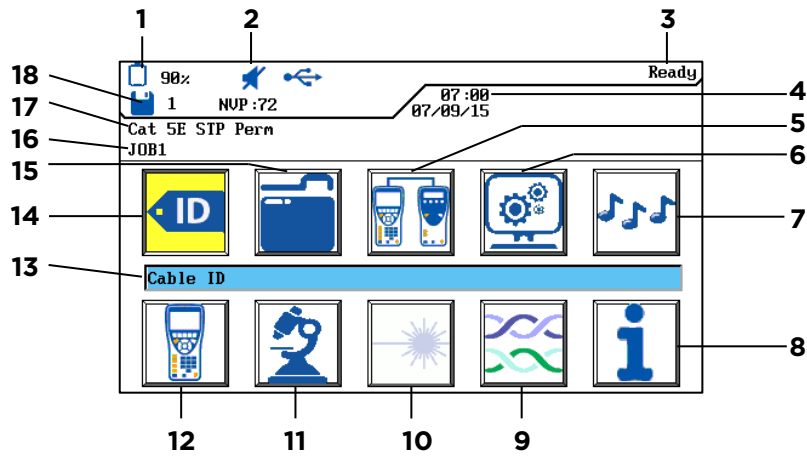

Fig. 3 TFT Display

	Display	Description
1	Power supply and charge state	Indicates battery operation or external power supply and charge state of battery pack (%).
2	Talkset indicator	Indicates whether talkset function is active.
3	Screen Title	Indicates that display handset (DH) or selected function is ready.
4	Time and Date	Displays the time and date.
5	Field calibration	Select the field calibration.
6	Preferences	Select the instrument preferences.
7	Toner	Select the tone generator.
8	General Help	Select the Help menu.
9	Cable Type	Select or edit the cable type.
10	Fiber	Select the fiber measurement.
11	Analyze	Perform individual cable tests in real time.
12	Instrument	Display the information on LanTEK III Cable Certifier.
13	Function Name	Displays the name of highlighted function.
14	Cable ID	Select cable naming function.
15	Stored Tests	Select file manager for the stored tests.
16	Job Name	Display the current job name.
17	Test Standard	Display the cable type selected for tests.
18	Records	Number of records stored.



### 2.1.3 Function Keys F1 to F10

Function keys F1 to F5 have dual functions (F6 to F10). Pressing down the Shift key while simultaneously pressing one of the function keys F1 to F5 will activate the 2nd function of the function key (example: Shift + F4 equals function F8).

### 2.1.4 Soft Key

Soft keys indicate possible menu options at the bottom of the screen. To select the according option, press the corresponding Function Key (F1 - F5) below the soft key. The example below shows the setting of Timeout options by using the soft keys at the bottom of the screen. The Value is set by Function Keys F1 (Increase) and F2 (Decrease).

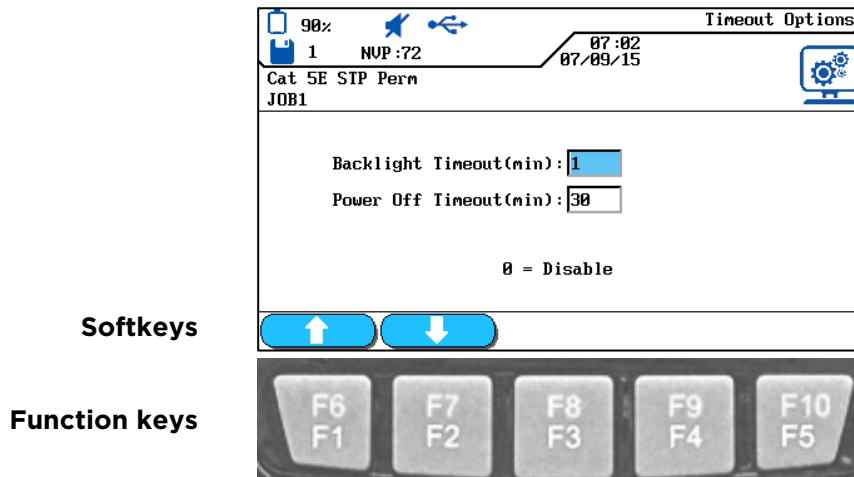

Fig. 4 Soft keys and function keys



## 2.2 The Remote Handset (RH)

The Remote handset (RH) works with the Display handset (DH) to perform autotests or individual real time analyze tests. The Remote handset (RH) is located at the end of the cable link and communicates with the Display handset (DH). To perform measurements, the Remote handset (RH) is automatically activated by the Display handset (DH).

### 2.2.1 Controls and Ports/Connectors

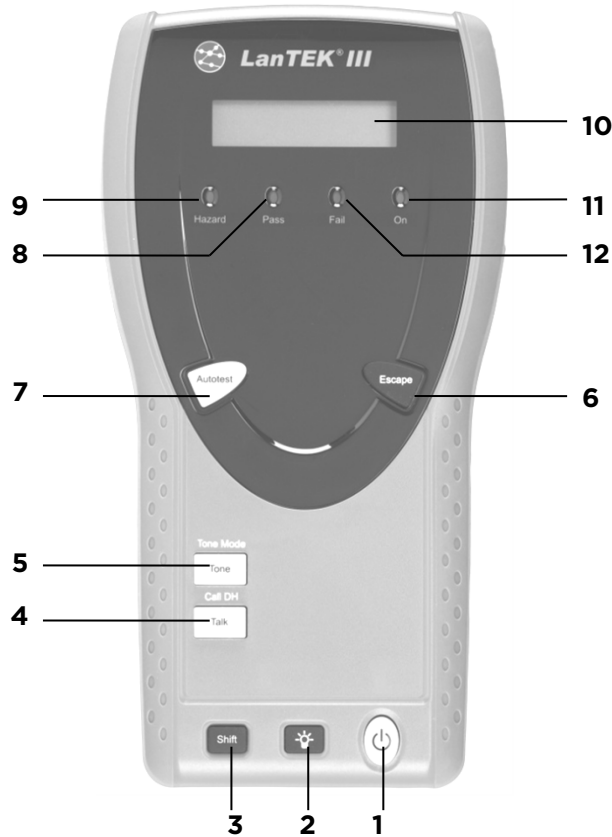

Fig. 5 The Remote Handset (RH) Front view

	Controls	Description
1	On/Off	Power the Remote handset (RH) on/off.
2	Dim Backlight	Dim Backlight in two stages.
3	Shift	Toggle key activities having dual functions.
4	Talk / Call DH	Activate Talkset function / call Remote handset (RH).
5	Tone / Tone Mode	Power the tone generator on/off.
6	Escape	Abort and exit the current action without making changes.
7	Autotest	Start the Autotest.
8	Pass LED	Test result: Passed.



	<b>Controls</b>	<b>Description</b>
9	Hazard LED	Excessive line voltage (TELCO): Excessive voltage at measurement input.
10	S/W-LCD Display	Two line alphanumeric display
11	On LED	The Remote Handset is on.
12	Fail LED	Test result: Fail.



**Fig. 6 The Remote Handset (RH) Rear and side view**

	<b>Ports/Connectors</b>	<b>Description</b>
13	Low-NEXT-Connector	Connect a test adapter.
14	Service and Maintenance Jack	Connection for service and maintenance work.
15	USB Device	Connect to a computer for firmware updates.
16	Talkset Jack	Connect a Talkset.
17	DC Input Jack	Connect an external power supply and charge battery pack.



## 2.3 Power Management

Both the Display (DH) and Remote (RH) handset use interchangeable rechargeable lithium-ion battery packs (Li-ion).

- The Display (DH) and Remote (RH) handsets can be run on battery power for approximately 18 hours. Actual battery power times depends on various factors, such as operating time versus standby time, use of the display backlight, and ambient temperature.
- When charge state of battery drops below the required voltage, a warning appears. Tester automatically shuts down before testing results are affected.
- To save battery power, the Display (DH) and Remote (RH) handset automatically power down after a certain period of inactivity.
- If the instrument will not be used for a prolonged time it is recommended that the battery protection strips be inserted to conserve battery charge.

### 2.3.1 Operating the Display and Remote handset from AC Power

The Display (DH) and Remote (RH) handset can also be operated from an external DC source (AC/DC adapter). The adapters are universally applicable.

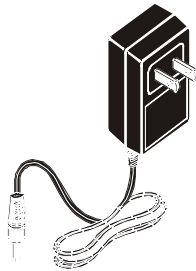

**Fig. 7 Adapter for LanTEK III DH and RH**

When using the AC/DC adapter to power the handsets, please note that:

- Both handset batteries will receive a trickle charge.
- A power plug will appear in the upper left corner of the Display handset (DH).



#### **CAUTION!**

**Only the adapter provided with the instrument shall be used. Other types of adapters may cause damage to the tester.**

#### **NOTE:**

**Do not connect to AC power when testing shielded cables, as this may result in ground loops which in turn can cause input protection warnings.**



### 2.3.2 Battery Charging

The batteries of the Display (DH) and Remote (RH) handset are charged using the adapter. It takes approximately 6-8 hours until the batteries in the instrument are fully charged. If the batteries are charged externally, charge time is approximately 4 hours.

During recharging, the instrument is calibrated to the corresponding battery. This ensures an accurate indication of the charge state at all times.

**NOTE:**

**Charge time depends on charge state of battery.**

When the battery is removed, the Display handset (DH) data and preferences are preserved in the flash ROM by a coin cell lithium battery.

### 2.4 Talkset

The LanTEK III Cable Certifier is designed for use with a talkset. This function allows communication between the Display (DH) and Remote (RH) handset through an externally attached microphone/headset. For this purpose, the Display (DH) and Remote (RH) handset must be connected to the test adapters through a cable.



## Chapter 3. Basics of the Cable Test

### 3.1 Testing of cables and relevant requirements

The following sections describe typical setup for permanent link and channel link testing.

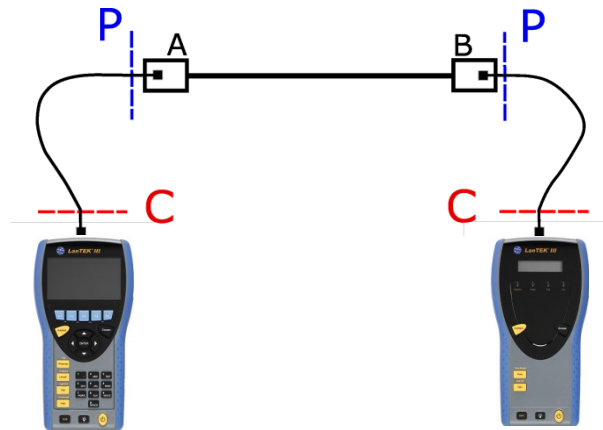

Fig. 8 Illustration of test setup

The area marked with **P** indicates the typical test setup of a **Permanent Link**.

The area marked with **C** indicates the typical test setup of a **Channel Link**.

#### 3.1.1 Setup for Permanent Link Test

The standards ANSI, EIA, TIA and ISO all differentiate between permanent link and channel link on specifications for testing of communication networks. A permanent link consists of up to 90 meters of horizontal cabling. (Maximum length limit applies to TIA standards only.) The permanent link shown above serves to certify the installation of the horizontal cabling before network connection and user hook-up. Adapters, patch cords and jumpers are excluded from testing.

Depending on the link under test, Permanent Link testing with LanTEKIII requires different adaptors:

- All RJ-45 cabling systems:
  - R161051 Permanent Link Adaptor
  - R161050 PL Adaptor Replacement Tips
- All non-45 cabling systems:
  - R161056 LanTEK® GG45-Adaptor
  - R161054 LanTEK® TERA-Adaptor
  - R161055 LanTEK® EC7-Adaptor

**NOTE:** Please visit [www.idealnetworks.net](http://www.idealnetworks.net) for an up to date full list of test adaptors.





### 3.1.2 Setup for Channel Link Test

A channel link includes all components of a cabling system. It consists of up to 90 meters horizontal cabling, including patch cords, jumpers, and test adapters at each cable end. The channel link shown above serves to certify the network installation, including the horizontal cable line and patch cord.

Channel link testing requires different test adaptors depending on the link under test:

R161056	LanTEK® GG45-Adaptor
R161054	LanTEK® TERA-Adaptor
R161055	LanTEK® EC7-Adaptor
R161053	LanTEK® Cat. 6A-Adaptor for RJ-45
R161052	LanTEK® Cat. 6-Adaptor for RJ-45

**NOTE:** Please visit [www.idealnetworks.net](http://www.idealnetworks.net) for an up to date full list of test adaptors.

### 3.1.3 Setup for other Test Methods

Depending on the testing requirements other than permanent link and channel, LanTEKIII offers various testing configurations:

- Coaxial testing

R161057	LanTEK® Coax-Kit
---------	------------------

- Testing of End-to-End (E2E) , Device- or Direct Attach Links:

R160050	LanTEK® Industrial Ethernet Kit
& R161053	& LanTEK® Cat. 6A-Adaptor for RJ-45
(both adaptors are required)	

**NOTE:** Please visit [www.idealnetworks.net](http://www.idealnetworks.net) for an up to date full list of test adaptors.



## Chapter 4. Preferences

Most instrument configurations are set by using the "Preferences" menu.

### 4.1 Open Preferences

1. Use **Arrow Keys** to navigate to "Preferences" and press **Enter**.

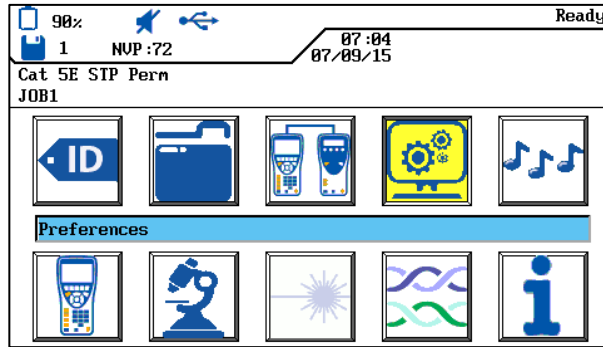

Fig. 9 Open Preferences

2. Next, the instrument preferences can be set by using the listed menus.

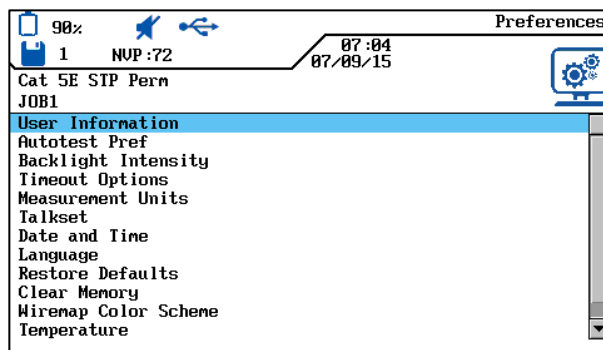

Fig. 10 Preference Selection

### 4.2 User Information

This menu can be used to provide information on assigned Technician, Company and Contractor.

1. Use **Arrow Keys** to navigate to "User Information" menu and press **Enter**.

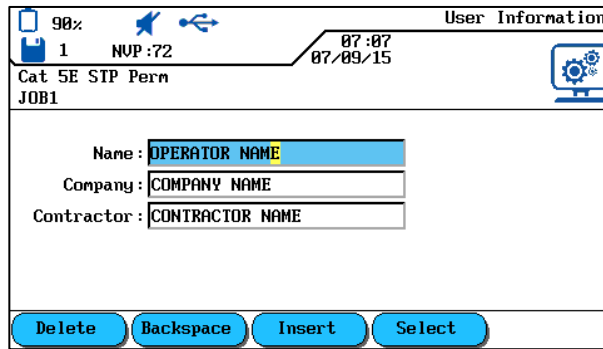

Fig. 11 User Information

2. Use **Arrow Keys** to navigate to desired option Name, Company or Contractor.
3. Use **Alphanumeric Keys** to enter the desired information.
4. Make corrections to entries by using the soft keys **Delete** (delete at cursor position), **Backspace** (delete characters to the left of cursor), **Insert** / **Overwrite** (insert alphanumeric characters at cursor position / overwrite highlighted entry).
5. Press **Enter** to save the information entered. Press **Escape** to exit the menu without making changes.

### 4.3 Autotest Options

Use this menu to set Autotest options.

1. Use **Arrow Keys** to navigate to "Autotest Options" menu and press **Enter**.

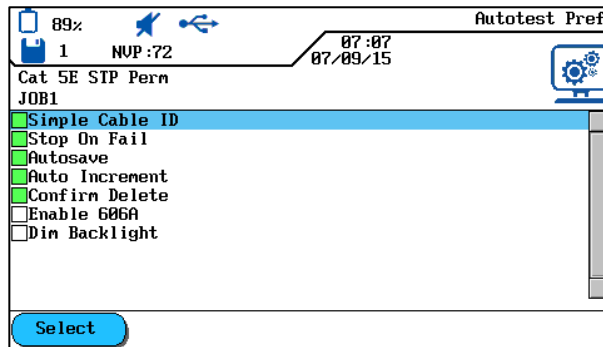

Fig. 12 Autotest Options

2. Use **Arrow** keys to select the desired option.
3. Use soft key **Select** to activate or deactivate the selected option. An activated option is indicated by the green box.
4. Press **Enter** to save the information entered. Press **Escape** to exit the menu without making changes.



## 4.4 Contrast

Use this menu to set Dim Backlight on screen.

1. Use **Arrow Keys** to navigate to "Contrast" menu and press **Enter**.

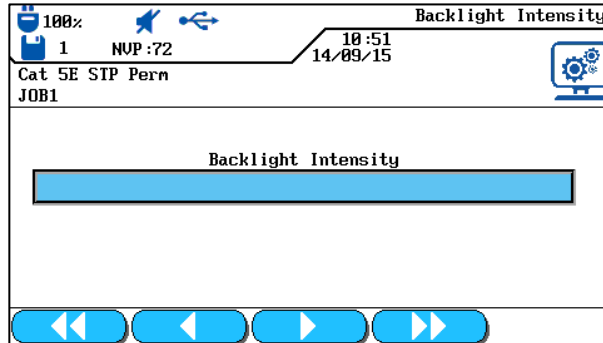



Fig. 13 Contrast

2. Use soft keys   to set backlight intensity.
3. Press **Enter** to save the information entered. Press **Escape** to exit the menu without making changes.

## 4.5 Timeout Options

Use this menu to set the time after which backlight automatically dims and the LanTEK®III Cable Certifier automatically shuts down when tester is not in use.

Default settings:

Backlight 1 minute  
Tester 30 minutes

1. Use **Arrow Keys** to navigate to "Timeout Options" menu and press **Enter**.

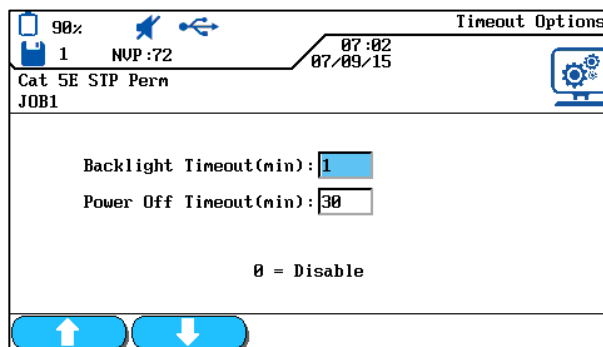



Fig. 14 Timeout Options

2. Use **Arrow keys** to select the desired option.
3. Use soft keys   to set the desired value.



4. Press **Enter** to save the information entered. Press **Escape** to exit the menu without making changes

## 4.6 Measurement Units

Use this menu to specify the measurement unit for length measurements ft or m (foot or meter). The default setting depends on the language selected.

1. Use **Arrow Keys** to navigate to "Measurement Units" menu and press **Enter**.

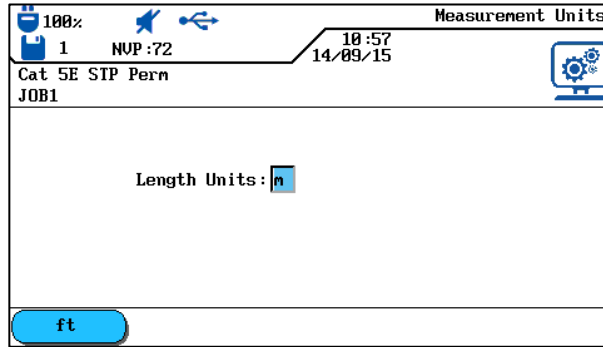



Fig. 15 Measurement Units

2. Use soft key  /  (foot / meter) to select the desired unit.
3. Press **Enter** to save the information entered. Press **Escape** to exit the menu without making changes.

## 4.7 Talkset

Use this menu to set signal strength of tone generator, volume of internal speaker and volume of talkset. Also use this menu to change the talkset mode.

1. Use **Arrow Keys** to navigate to "Talkset" menu and press **Enter**.

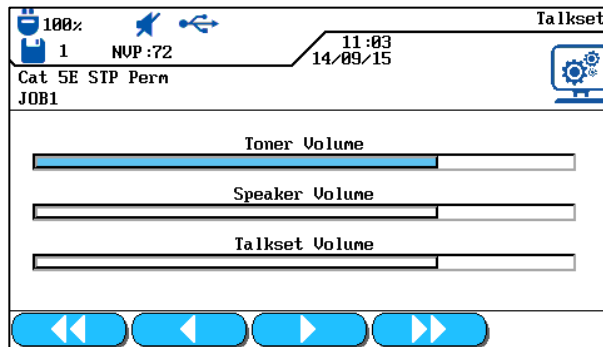





Fig. 16 Talkset

2. Use **Arrow Keys** to select the desired option.



3. On options *Toner Volume*, *Speaker Volume* or *Talkset Volume*, use soft keys     to set signal strength and volume.
4. Press **Enter** to save the information entered. Press **Escape** to exit the menu without making changes.



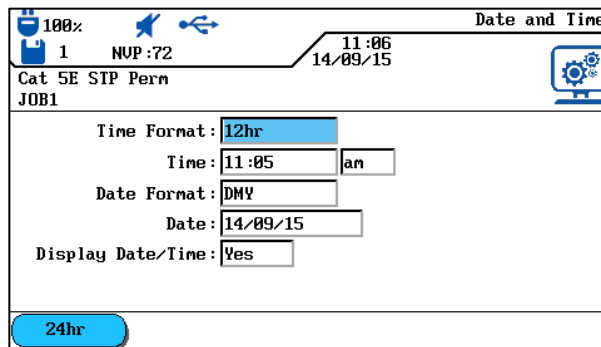

## 4.8 Date and Time

Accurate date and time settings are important for the reliable identification of records and test reports.

1. Use **Arrow Keys** to navigate to "Date and Time" menu and press **Enter**.

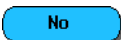
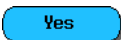

**Fig. 17 Date and Time**

2. Use soft key  /  to set the desired *Time format*.
3. Use **Arrow Keys** to navigate to option *Time*.
4. Use **Alphanumeric Keys** to enter the time.
5. Use **Arrow Keys** to navigate to option *Date Format*.
6. Use soft keys   to select the desired format MDY (month/day/year), DMY (day/month/year) or YMD (year/month/day).
7. Use **Arrow Keys** to navigate to option *Date*.
8. Use **Alphanumeric Keys** to enter the date.
9. Use **Arrow Keys** to navigate to option *Date/Time Display*.
10. Use soft key  /  to select the desired setting.
11. Press **Enter** to save the information entered. Press **Escape** to exit the menu without making changes.



### 4.9 Restore Default

Use this menu to reset all tester settings to their factory defaults. Using this option will not delete stored tests.

1. Use **Arrow Keys** to navigate to "Restore Defaults" menu and press **Enter**.

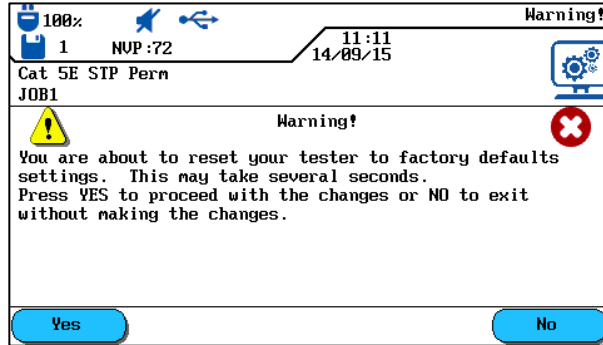



Fig. 18 Restore Defaults

2. Use the soft key  to accept default settings.
3. Use the soft key  to exit the screen without making changes.

### 4.10 Clear Memory

Use this menu to clear all records from the tester memory at one time.



**CAUTION!**

**When using the "Clear Memory" menu, the records cannot be restored. This will permanently delete all stored tests.**

1. Use **Arrow Keys** to navigate to Clear Memory menu and press **Enter**.

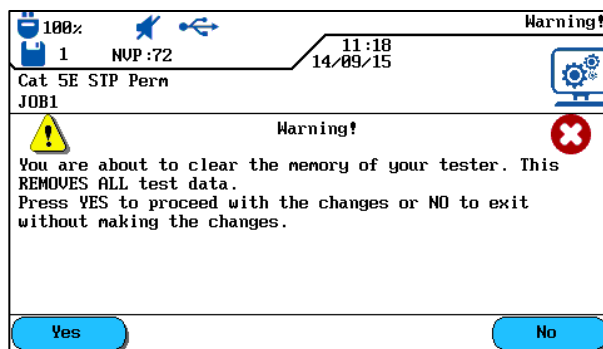



Fig. 19 Clear Memory

2. Use the soft key  to clear the memory of the Cable Certifier.
3. Use the soft key  to exit the screen without making changes.





## 4.11 Temperature

Use this menu to select the required temperature in *Celsius* or *Fahrenheit*.

1. Use **Arrow Keys** to navigate to "Temperature" menu and press **Enter**.

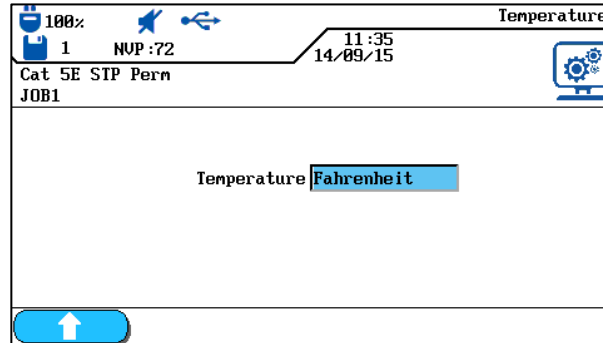



Fig. 20 Temperature

2. Use the soft keys   to select the desired temperature.
3. Press **Enter** to save the information entered. **Escape** allows you to exit the menu without making changes.



## Chapter 5. Autotest

Using Autotest, the installation can be measured and tested in a simple and fast way. After pressing the **AUTOTEST** key, LanTEK'III Cable Tester automatically performs a number of pre-programmed single tests. Autotest can be enabled from the Display (DH) or Remote (RH) handset.

Selection of single tests from the test series depends on the type of cabling to be tested. Specification of the test series is based on approved or recommended standards, as well as specific parameters.

After the test series is completed, LanTEK'III Cable Tester displays an overall passed/failed result, as well as the individual passed/failed results.

### Preferences on Display handset (DH)

- Set Autotest Pref.
- Select job folder.
- Set cable name (cable ID).
- Select cable type.

### Connections

- Separate cable line to be tested from all network components.
- Using suitable patch cords, connect the Display handset (DH) to one end of the cable line (link), and the Remote handset (RH) to the opposite end of the cable line (link).

### Test run

By pressing the **AUTOTEST** key, the test procedures described below are initiated:

- First, the Display handset (DH) attempts to establish a connection to the Remote handset (RH) via a correctly connected wire pair. If connection cannot be established, the Display handset (DH) will show the message "Searching for Remote (RH). The search is continued until the Autotest is manually cancelled or the Remote handset (RH) is located.
- After connection to the Remote handset (RH) has been successfully established, its serial number is read out to check if current configuration data are available.

#### NOTE:

**If during the last 7 days no calibration has been performed on the identified Remote handset (RH), the Autotest is cancelled and the user receives a message that a field calibration is required.**

- Display handset (DH) continues the Autotest if serial number is valid. Most Autotests start with the Wiremap test for twisted pair cables.
- Following the Wiremap test, the other single tests that have been defined for the currently selected cable type are performed.
- After completion of Autotest, all test data can be displayed, saved and printed.
- The test results of the last Autotest are stored in the non-volatile memory and remain available for viewing even after the LanTEK'III Cable Tester is powered on or powered down.
- The test results of the last Autotest remain in the non-volatile memory until they are overwritten by new test results, the memory is deleted or an analysis test is conducted.



### Overall Passed/Failed Result

The overall result of Autotest is displayed after test series is completed.

Symbol	Overall Autotest Result
	The overall Autotest receives a passing grade if all single tests have been passed or passed*.
	The overall Autotest receives a failing grade if at least one single test has failed or failed*.

### 5.1 Set Autotest Pref

1. Open "Preferences" on start screen.
2. In "Preferences" open *Autotest Pref*.
3. Use **Arrow Keys** to navigate to the according Autotest Pref. Use soft key  to enable or disable the selected Autotest Pref. Enabled Autotest Pref are indicated by green boxes.

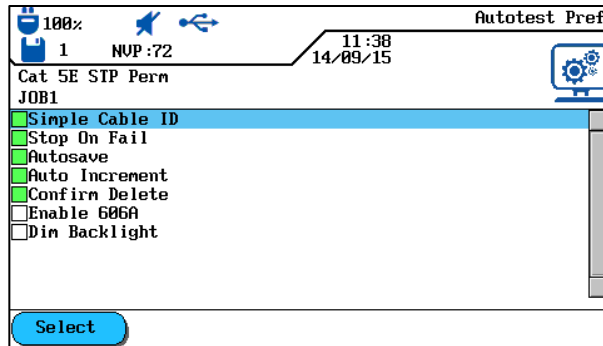

Fig. 21 Autotest Pref

4. Press **Enter** to save the information entered. **Escape** allows you to exit the menu without making changes.

Autotest Pref	Description
<i>Simple cable ID</i>	Assign name to cable line and set/reset meter reading of tests. The name can be assigned as simple cable ID or double cable ID (Cable From/Cable To). <b>NOTE:</b> <b>If Simple Cable ID is <u>not</u> enabled, the cable name assigned will be the default cable ID. In addition to cable name and test meter, an initial value and a final value can be set, and the way of counting can be specified.</b>
<i>Stop on Fail</i>	The Autotest is stopped after the first failed test.
<i>Autosave</i>	The LanTEK III Cable Tester automatically names and saves all results of <u>passed Autotests</u> in the current job folder.
<i>Auto Increment</i>	The test meter for the cable ID is automatically advanced after each Autotest.
<i>This will permanently delete the Tests / Jobs from the tester</i>	Enables confirmation prompt prior to deleting data.



Autotest Pref	Description
<i>Enable 606A</i>	Enable labelling standard TIA/EIA 606-A for telecommunication infrastructure as cable ID. <b>NOTE:</b> <b>If labelling standard TIA/EIA 606-A is enabled; the selected cable name (simple cable ID/default cable ID) is not applied.</b>
<i>Enable Wiremap On Failed Autotest.</i>	In case of failed Autotest, it determines whether another fault analysis will automatically be performed.

## 5.2 Select Job Folder

The name of the current job folder is shown in the TFT display on the ready screen. To save the Autotest it is possible to keep this job folder, enable another existing job folder, or create a new job folder.

### 5.2.1 Enable Existing Job Folder

1. Use **Arrow keys** to navigate to "File" and press **Enter** to open the job list.

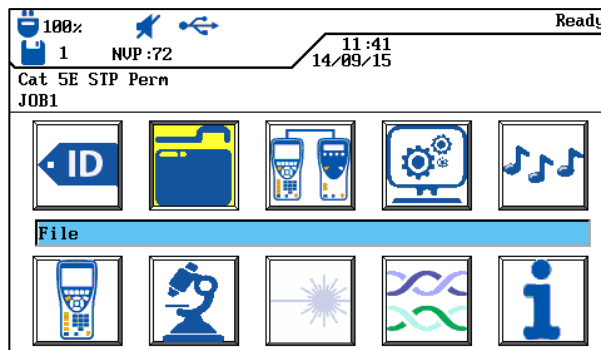

Fig. 22 File

2. Use **Arrow Keys** to navigate to the desired job folder. The display is highlighted **blue**.

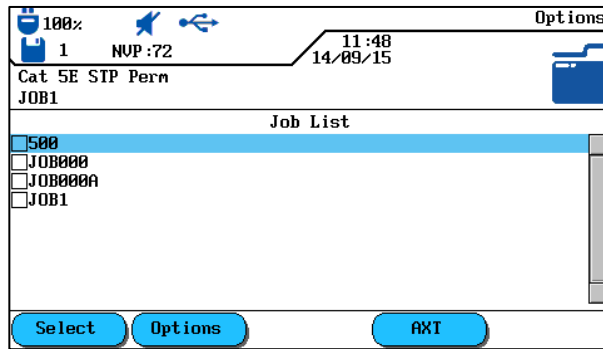

Fig. 23 Job List

3. Use soft key **Options** to open job options.
4. Use **Arrow Keys** to navigate to option *Make Job Current*. The display is highlighted blue.

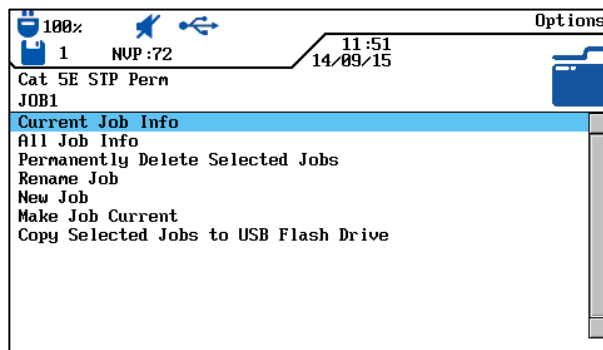

Fig. 24 Job Options (example Current Job Info)

5. Press **Enter** to save the information entered. **Escape** allows you to exit the menu without making changes.
6. When confirming with **Enter**, the name of the selected job folder will appear on the ready screen.

### 5.2.2 Create New Job Folder

1. Use soft key **Options** to open job options in job list.

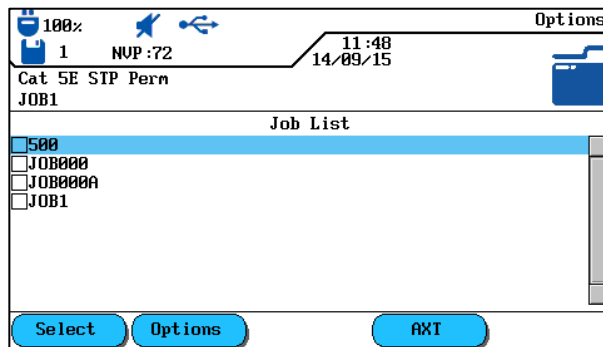
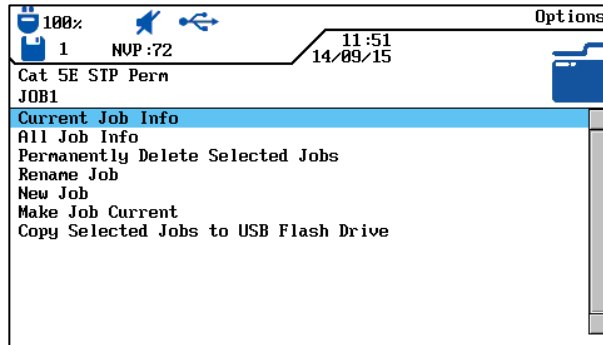

Fig. 25 Job List



Use **Arrow Keys** to navigate to option *New Job* and press **Enter**.



**Fig. 26 Job Options**

Use **Alphanumeric Keys** to enter the desired information.

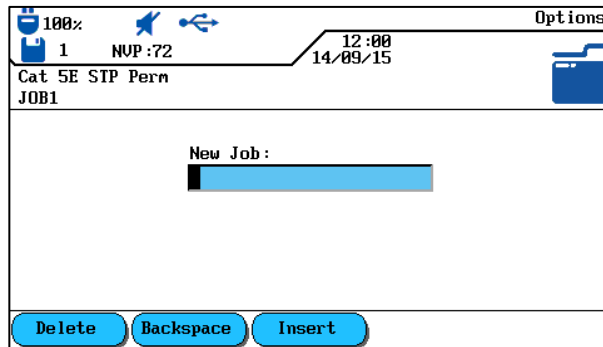

**Fig. 27 New Job**

Make corrections to entries by using the soft keys **Delete** (delete at cursor position), **Backspace** (delete characters to the left of cursor), **Insert** / **Overwrite** (insert alphanumeric characters at cursor position / overwrite highlighted entry).

Press **Enter** to save the information entered. **Escape** allows you to exit the menu without making changes.

When confirming with **Enter**, the name of the new job folder will appear on the ready screen.

### 5.3 Set Cable Name (cable ID)

The cable name of the cable lines in an Autotest consists of a fixed *Cable Name* and a variable *Current Value* (4-digit test meter) that automatically increments. Depending on selected Autotest Pref it is also possible to specify structure and way of counting.

1. Use **Arrow keys** to navigate to "Cable ID" and press **Enter**.

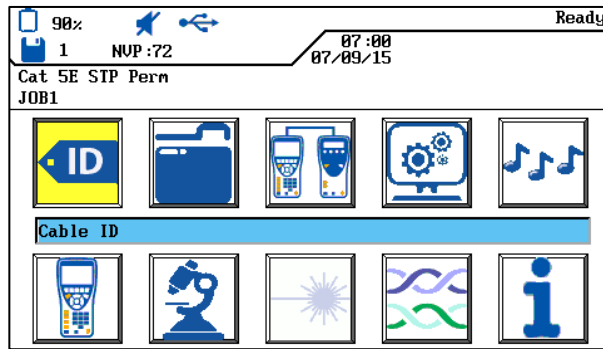

Fig. 28 Cable ID

The name used last will appear:

- *Single Cable ID* (1 name is assigned to each cable).
- or
- *Double Cable ID* (2 names are assigned to each cable, one for the start and one for the end of the cable).

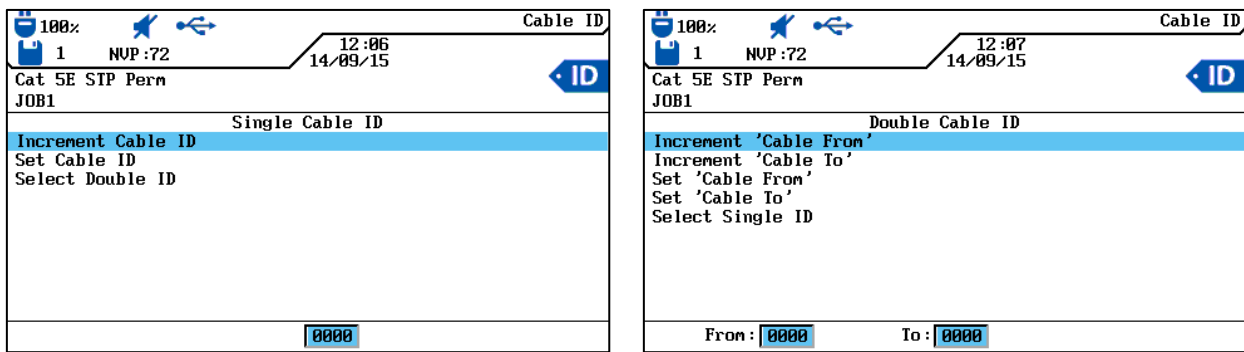

Fig. 29 Cable ID

- *Increment...* when pressing **Enter**, the current value of the test meter, shown in view below, is incremented by one position.
- *Set...* opens menu for cable name.
- *Select...* switches between *Single Cable ID* and *Double Cable ID*.

### 5.3.1 Simple Cable ID

2. Use **Arrow keys** to navigate in "Cable ID" view to option *Set...* and press **Enter**.

#### Single Cable ID (1 cable name)

3. Use **Alphanumeric Keys** to enter a *Cable Name* for the test portion.
4. Use **Alphanumeric Keys** to reset the *Current Value* of the test meter, or enter an arbitrary value.
5. Make corrections to entries by using the soft keys **Delete** (delete at cursor position), **Backspace** (delete characters to the left of cursor), **Insert** / **Overwrite** (insert alphanumeric characters at cursor position / overwrite highlighted entry).



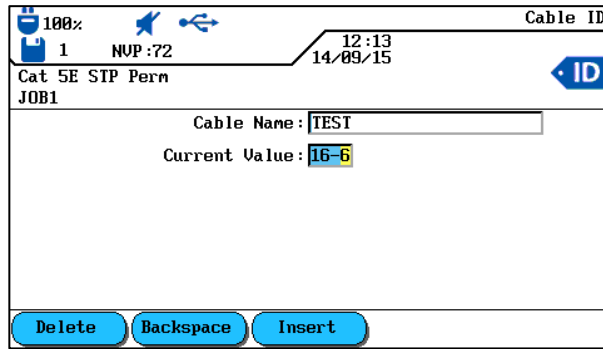

Fig. 30 Single Cable ID

6. Press **Enter** to save the information entered. **Escape** allows you to exit the menu without making changes.

### Double Cable ID (2 cable names, start/end)

7. Use **Alphanumeric Keys** to enter a *Cable Name* for the *Cable From/Cable To* of test portion.
8. Use **Alphanumeric Keys** to reset the *Current Value* of the test meter, or enter an arbitrary value.
9. Make corrections to entries by using the soft keys **Delete** (delete at cursor position), **Backspace** (delete characters to the left of cursor), **Insert** / **Overwrite** (insert alphanumeric characters at cursor position / overwrite highlighted entry).

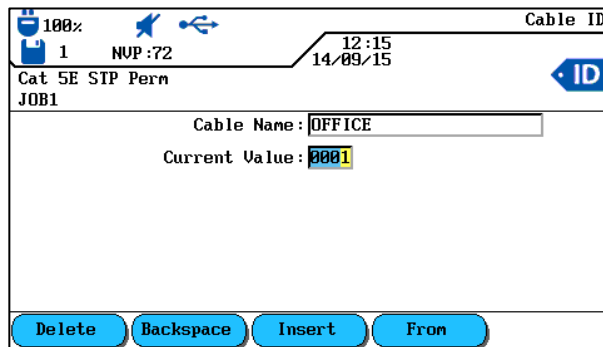

Fig. 31 Double Cable ID

10. Use soft keys **From** and **To** to switch between the views *Cable From* and *Cable To*.
11. Use **Alphanumeric Keys** to enter a *Cable Name* for the *Cable From/Cable To* of test portion.
12. Use **Alphanumeric Keys** to reset the *Current Value* of the test meter, or enter an arbitrary value.





13. Make corrections to entries by using the soft keys **Delete** (delete at cursor position), **Backspace** (delete characters to the left of cursor), **Insert** / **Overwrite** (insert alphanumeric characters at cursor position / overwrite highlighted entry).
14. Press **Enter** to save the information entered. **Escape** allows you to exit the menu without making changes.

### 5.3.2 Default Cable ID

Simple cable ID was not selected in Autotest Pref.

1. Use Arrow keys to navigate in "Cable ID" view to option Set... and press **Enter**.

#### Simple Cable ID (1 cable name)

2. Use **Alphanumeric Keys** to enter a *Cable Name* for the test portion.
3. Use **Alphanumeric Keys** to reset the *Current Value* of the test meter, or enter an arbitrary value.
4. Use **Alphanumeric Keys** to enter an arbitrary value for *Start* and *End*. Meter is reset after reaching final value.
5. Make corrections to entries by using the soft keys **Delete** (delete at cursor position), **Backspace** (delete characters to the left of cursor), **Insert** / **Overwrite** (insert alphanumeric characters at cursor position / overwrite highlighted entry).
6. Use symbol  to lock a position into entered value. Use symbol  to enable Auto Increment of a character.

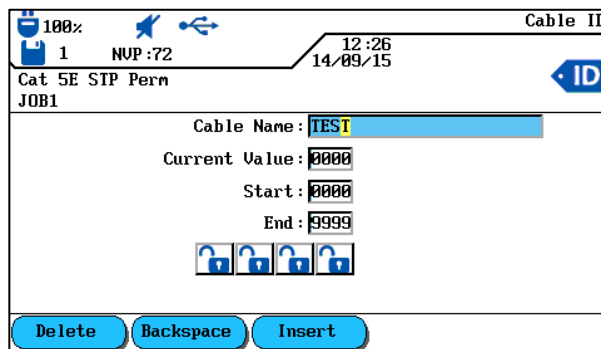

Fig. 32 Single Cable ID

7. Press **Enter** to save the information entered. **Escape** allows you to exit the menu without making changes.

#### Double Cable ID (2 cable names, start/end)

1. Use **Alphanumeric Keys** to enter a *Cable Name* for the *Cable From*/*Cable To* of test portion.
2. Use **Alphanumeric Keys** to reset the *Current Value* of the test meter, or enter an arbitrary value.
3. Use **Alphanumeric Keys** to enter an arbitrary value for *Start* and *End*. Meter is reset after reaching final value.



4. Make corrections to entries by using the soft keys **Delete** (delete at cursor position), **Backspace** (delete characters to the left of cursor), **Insert** / **Overwrite** (insert alphanumeric characters at cursor position / overwrite highlighted entry).
5. Use symbol to lock a position into entered value. Use symbol to enable Auto Increment of a character.

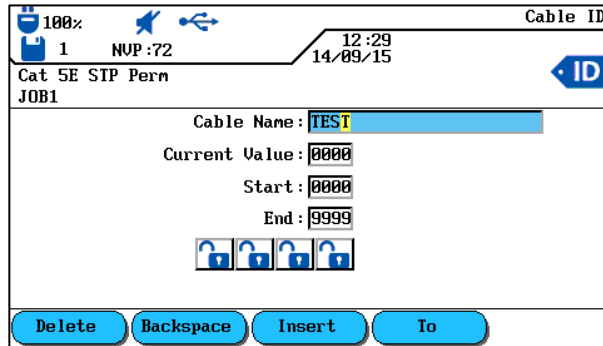

Fig. 33 Double Cable ID

6. Use soft keys **From** and **To** to switch between the views *Cable From* and *Cable To*.
7. Use **Alphanumeric Keys** to enter a *Cable Name* for the *Cable From/Cable To* of test portion.
8. Use **Alphanumeric Keys** to reset the *Current Value* of the test meter, or enter an arbitrary value.
9. Use **Alphanumeric Keys** to enter an arbitrary value for *Start* and *End*. Meter is reset after reaching final value.
10. Make corrections to entries by using the soft keys **Delete** (delete at cursor position), **Backspace** (delete characters to the left of cursor), **Insert** / **Overwrite** (insert alphanumeric characters at cursor position / overwrite highlighted entry).
11. Use symbol to lock a position into entered value. Use symbol to enable Auto Increment of a character.
12. Press **Enter** to save the information entered. **Escape** allows you to exit the menu without making changes.

### Examples for Default Cable ID

In default setting, the meter starts at 0000 and ends at 9999. The four (4) positions are enabled and incrementing.

Default	Example 1	Example 2	Example 3	
			"Cable From"	"Cable To"
Cable name: TEST	Cable name: PANEL 1	Cable name: PANEL 2	Cable name: OFFICE 2	Cable name: Distributor
Current: 0 0 0 0	Current: 0 0 0 0	Current: 0 1 8 A	Current: 0 0 0 0	Current: 0 0 0 A
Start: 0 0 0 0	Start: 0 0 0 0	Start: 0 0 0 A	Start: 0 0 0 0	Start: 0 0 0 A
End: 9 9 9 9	End: 0 0 2 2	End: 0 9 9 D	End: 9 9 9 9	End: 0 0 9 D
0 0 0 0	0 0 0 0	0 1 8 A	0 0 0 0	0 0 0 A



0 0 0 1	0 0 0 1	0 1 8 B	0 0 0 1	0 0 0 B
0 0 0 2	0 0 0 2	0 1 8 C	0 0 0 2	0 0 0 C
0 0 0 3	0 0 1 0	0 1 8 D	0 0 0 3	0 0 0 D
0 0 0 4	0 0 1 1	0 1 9 A	0 0 0 4	0 0 1 A
0 0 0 5	0 0 1 2	0 1 9 B	0 0 0 5	0 0 1 B
0 0 0 6	0 0 2 0	0 1 9 C	0 0 0 6	0 0 1 C
0 0 0 7	0 0 2 1	0 1 9 D	0 0 0 7	0 0 1 D
0 0 0 8	0 0 2 2	0 2 0 A	0 0 0 8	0 0 2 A
0 0 0 9	0 0 0 0	0 2 0 B	0 0 0 9	0 0 2 B
0 0 1 0	0 0 0 1	0 2 0 C	0 0 1 0	0 0 2 C
0 0 1 1	0 0 0 2	0 2 0 D	0 0 1 1	0 0 2 D
0 0 1 2	0 0 1 0	0 2 1 A	0 0 1 2	0 0 3 A

### 5.4 Labeling Standard TIA/EIA 606-A

The standards TIA/EIA 606-A for telecommunication infrastructure include the following elements:

- Horizontal cable arrangements and cabling.
- Backbone cable arrangements and cabling.
- Grounding/potential equalization for telecommunication systems.
- Rooms (e.g. service connection room, telecommunication room, equipment Room and fire protection installations.)

The mentioned standards affect the administration of telecommunication infrastructure by:

- Assigning identifiers to infrastructure components.
- Specifying information elements on which the infrastructure is based.
- Specifying the relation between these records to ensure the contents.
- Specifying reports that contain information on record groups and
- Specifying the requirements on graphs and symbols.



### 5.4.1 Cable Name in Format TIA/EIA 606A

To determine cable name, a structure for the test portion is created. The three (3) cable parameters 606A Drop, 606A Backbone and 606A Backbone Pair/Fiber are available.

1. Use **Arrow keys** to navigate to "Cable ID" and press **Enter**.

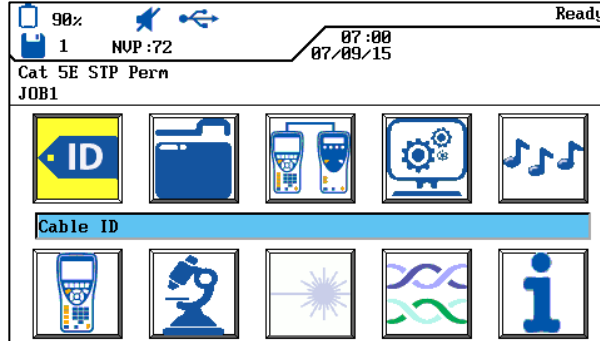

Fig. 34 Cable ID

### 5.4.2 Cable Parameter 606A Drop

Name of horizontal cable line (e.g. 1 building, 1 floor, 1 distribution, sockets)

2. Use soft key **Drop** to select cable parameter 606A Drop.

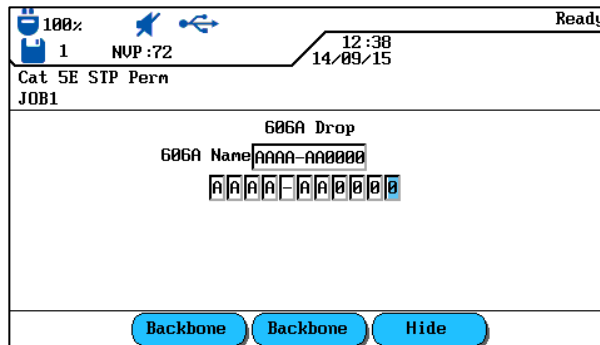

Fig. 35 Cable Parameter 606A Drop

AAA	A	-	AA	0000
Floor	Telecom room		Panel	Port

3. Use **Left/Right Arrow Keys** to navigate to desired position in port area. Use **Up/Down Arrow Keys** to assign characters and numbers.
4. Proceed in the same manner with positions **Panel**, **Telecom Room** and **Floor**.
5. Use soft key **Hide** to hide individual positions. Assembling the cable line automatically generates the *606A-Name*.
6. Press **Enter** to save the cable name. Use **Escape** to exit menu without making changes.



### 5.4.3 Cable Parameter 606A Backbone

Name of a horizontal and vertical cable line (e.g. several floors, several distributions, sockets).

- 8. Use soft key **Backbone** to select cable parameter 606A Backbone.

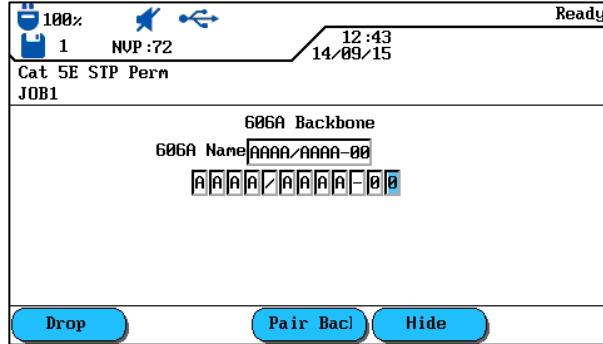

Fig. 36 Cable Parameter 606A Backbone

AA	A	/	AAA	A	-	00
Floor	Telecom room		Floor	Telecom room		Port

- 9. Use **Left/Right Arrow Keys** to navigate to desired position in port area. Use **Up/Down Arrow Keys** to assign characters and numbers.
- 10. Proceed in the same manner with positions **Telecom Room** and **Floor**.
- 11. Use soft key **Hide** to hide individual positions. Assembling the cable line automatically generates the *606A-Name*.
- 12. Press **Enter** to save the cable name. Use **Escape** to exit menu without making changes.

### 5.4.4 Cable Parameter 606A Backbone Pair/Fiber

Name of a horizontal and vertical cable line with a pair/fiber connection (e.g. building, several floors, several distributions, sockets).

- 1. Use soft key **Pair Back** to select cable parameter 606A Backbone Pair/Fiber.

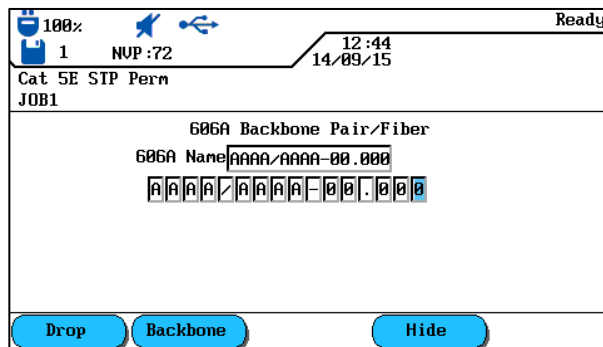

Fig. 37 Cable Parameter 606A Backbone Pair/Fiber



AAA	A	/	AAA	A	-	00	.	000
Floor	Telecom room		Floor	Telecom room		Port		Pair

2. Use **Left/Right Arrow Keys** to navigate to desired position in **Pair** area. Use **Up/Down Arrow Keys** to assign characters and numbers.
3. Proceed in the same manner with positions **Port**, **Telecom Room**, and **Floor**.
4. Proceed in the same manner with positions **Telecom Room** and **Floor**.
5. Use soft key **Hide** to hide individual positions. Assembling the cable line automatically generates the *606A-Name*.
6. Press **Enter** to save the information entered. **Escape** allows you to exit the menu without making changes.

### 5.5 Select Twisted Pair Cabling

1. Open "Cable Type" on start screen.
2. Use **Arrow Keys** to navigate to installation type of cable line to be tested (*Twisted Pair Perm*, *Twisted Pair Basic* or *Twisted Pair Channel*) and confirm with **Enter**.

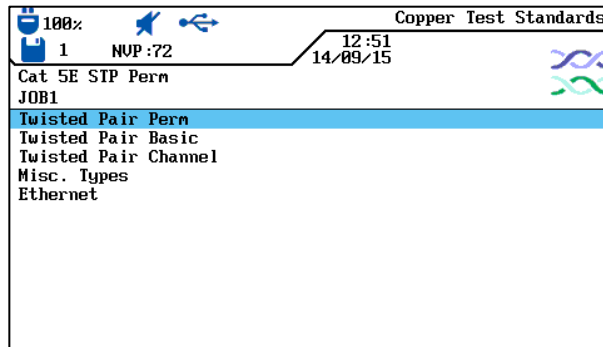

Fig. 38 Cable Type

3. Use **Arrow Keys** to navigate to desired cable type.

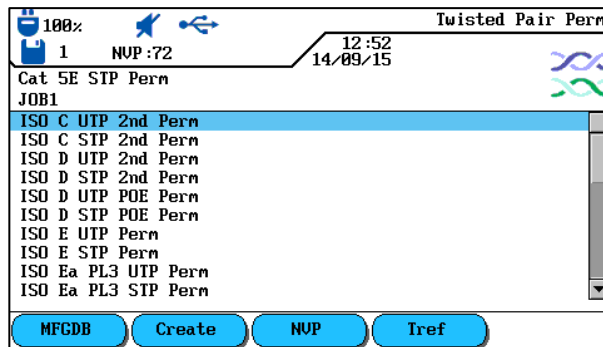

Fig. 39 Example Twisted Pair Perm

4. Press **Enter** to save the information entered. **Escape** allows you to exit the menu without making changes.

Or



5. Use available soft key options to specify a cable type, create a cable type, edit NVP values or enter reference temperature.

### 5.5.1 Specify Cable Type

1. Use soft key **MFCDB** to open select menu to specify the selected cable type.
2. Use **Arrow keys** to navigate to desired specification and confirm with **Enter**.

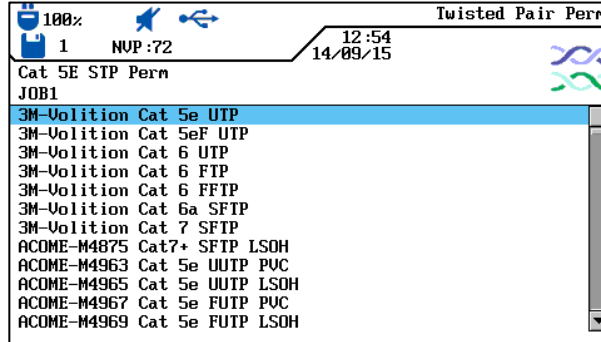

Fig. 40 Specification of Cable Type

3. Press **Enter** to save the information entered. **Escape** allows you to exit the menu without making changes.

### 5.5.2 Create Cable Type

1. Use soft key **Create** to open select menu for individual creation of a cable type.
2. Use **Arrow keys** in Select Menu to navigate to option *Frequency Range* and confirm with **Enter**.

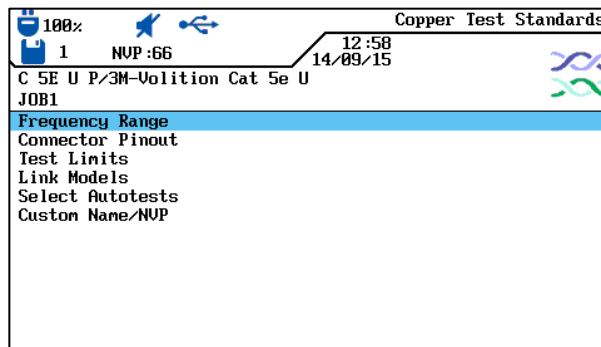

Fig. 41 Select Menu

3. Use **Arrow Keys** to navigate to the individual boxes and use **Alphanumeric Keys** to assign start and stop frequencies for *Certification* and *Performance Range*.



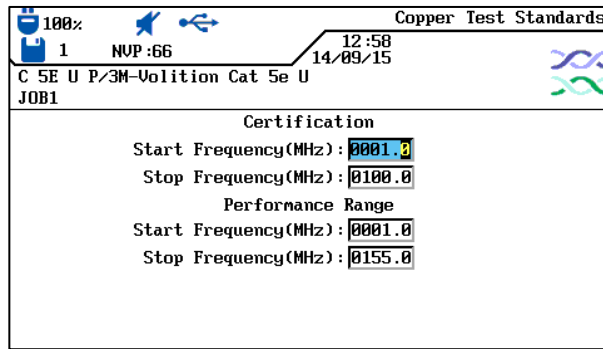

Fig. 42 Frequency Range

4. Press **Enter** to save the information entered. **Escape** allows you to exit the menu without making changes.
5. Use **Arrow keys** in Select Menu to navigate to option *Connector Pinout* and confirm with **Enter**.
6. Use **Arrow keys** to navigate to desired pairings and enable or disable your selection with soft key **Select**. An enabled pairing is indicated by the green box.

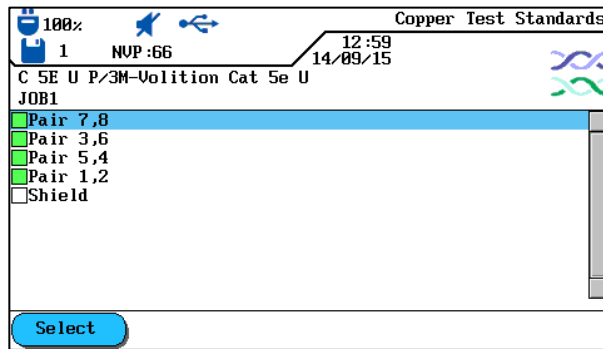

Fig. 43 Connector Pinout

7. Press **Enter** to save the information entered. **Escape** allows you to exit the menu without making changes.
8. Use **Arrow keys** in Select Menu to navigate to option *Test Limits* and confirm with **Enter**.
9. Use **Arrow keys** to navigate to the individual boxes and assign desired limit with the **Alphanumeric Keys**.

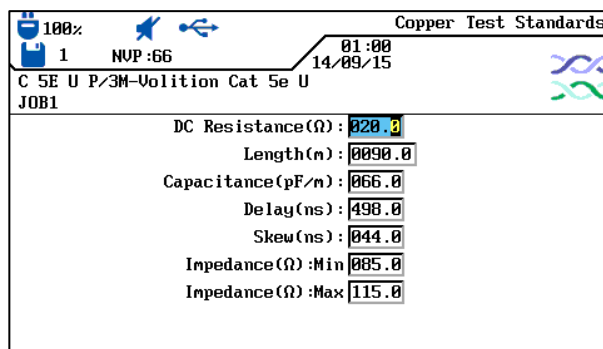

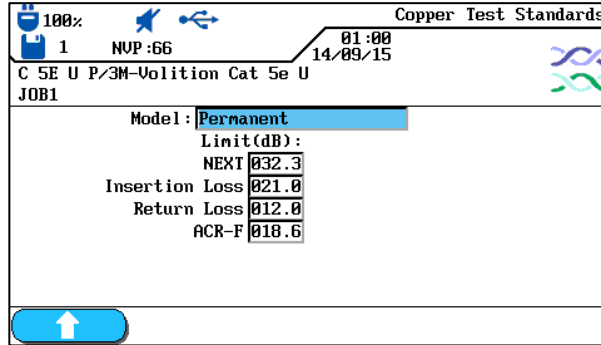



Fig. 44 Test Limits



10. Press **Enter** to save the information entered. **Escape** allows you to exit the menu without making changes.
11. Use **Arrow keys** in Select Menu to navigate to option *Link Models* and confirm with **Enter**.
12. Use soft key  to select the link model *Perm, Basic, Channel, EIA, Flat Rate, Ignore* or *Skip*.





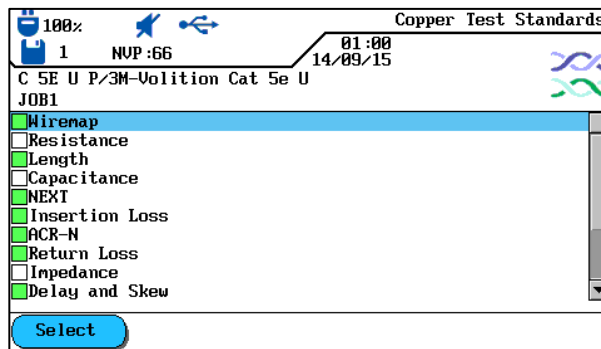

**Fig. 45 Link Models**

13. Use **Arrow Keys** to navigate to the individual boxes and use **Alphanumeric Keys** to assign the values for *NEXT, Insertion Loss, Return Loss* and *ACR-F (ELFEXT)*.
14. Press **Enter** to save the information entered. **Escape** allows you to exit the menu without making changes.
15. Use **Arrow keys** in Select Menu to navigate to option *Select Autotest* and confirm with **Enter**.
16. Prepare the desired measuring modes for the Autotest by using **Arrow Keys** to navigate to the desired measuring modes. Enable or disable your selection with soft key . An enabled measuring mode is indicated by the green box.



**Fig. 46 Select Autotests**

17. Press **Enter** to save the information entered. **Escape** allows you to exit the menu without making changes.
18. Use **Arrow keys** in Select Menu to navigate to option *Custom Name/NVP* and confirm with **Enter**.
19. Use **Alphanumeric Keys** to assign a name for the created cable type.
20. Make corrections to entries by using the soft keys  (delete at cursor position),  (delete characters to the left of cursor),  /  (insert alphanumeric characters at cursor position / overwrite highlighted entry).

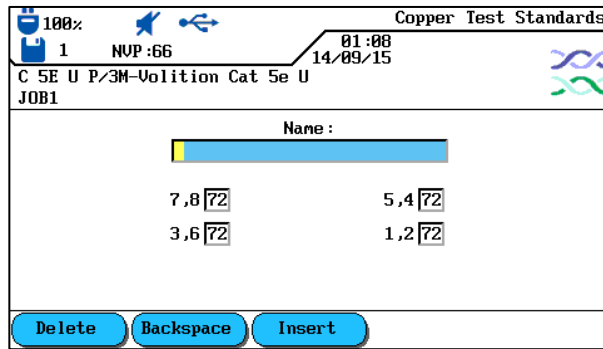

Fig. 47 Custom Name/NVP

21. Use **Arrow keys** to navigate to the individual boxes and assign desired NVP with the **Alphanumeric Keys**.
22. Press **Enter** to save the information entered. **Escape** allows you to exit the menu without making changes.

### 5.5.3 Edit and Calculate NVP

1. Use soft key **NVP** to open Select Menu for editing and calculating NVP.
2. Use **Arrow keys** to navigate to the individual boxes and assign desired NVP with the **Alphanumeric Keys**.

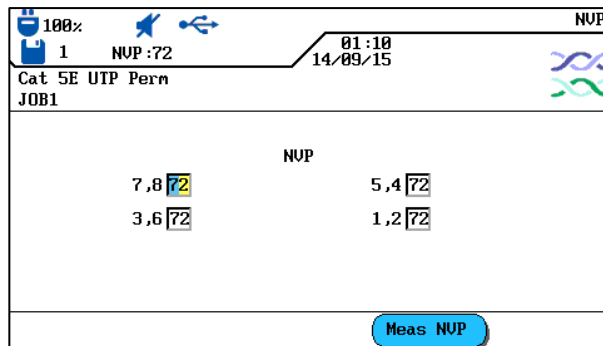

Fig. 48 NVP

3. Use soft key **Meas NVP** to open menu for entering cable length.
4. Use **Arrow Keys** to navigate to box and use **Alphanumeric Keys** to assign *Cable Length (m)*.
5. Connect cable to be tested.

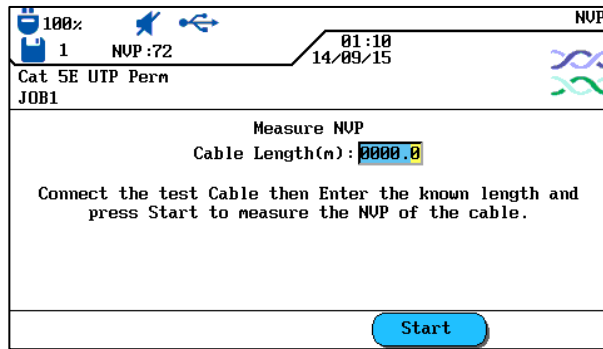



Fig. 49 Cable Length

6. Use soft key  to start calculation of NVP.
7. Press **Enter** to save NVP. Use **Escape** to exit menu without making changes.

### 5.5.4 Enter Reference Temperature

1. Use soft key  to open Select Menu for changing ambient temperature.
2. Use **Alphanumeric Keys** to assign reference temperature.

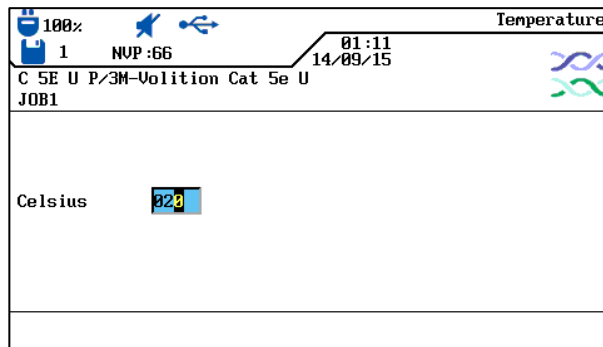

Fig. 50 Reference Temperature

3. Press **Enter** to save the reference temperature. Use **Escape** to exit menu without making changes.



## 5.6 DualMODE™ Function for Twisted Pair Cabling

The DualMODE™ function of LanTEK III Cable tester allows measurement in compliance with 2 limits in one single Autotest. Thus, for instance, simultaneous Channel Link and Permanent Link measurements can be performed.

With DualMODE™ it is possible to perform other important tests. Let us assume you are installing a Cat-6 system in a country whose government agency uses a national standard based on ISO. But you are working with cables and connection components manufactured by a company in the US. The government agency can request a certification according to ISO Class E from the installer. However, for warranty reasons the US company might insist on TIA 568 Category 6. Therefore, in the past both certifications were required - in compliance with ISO and TIA - and the increased costs had to be passed on to the customer. In contrast, DualMODE™ makes it possible to perform both certifications at the same time, in compliance with ISO Class E Permanent Link and TIA 568B Category 6. The costs are the same as for one test.

Another example for the use of DualMODE™ is the calculation of margins in relation to higher bandwidth for future applications. Up to now you had to check the certification documents for Category 6 Permanent Link and assess whether adequate margins for transmission of applications at higher bandwidth are available. However, assessment of the complete final data would also require a certification according to Category 6<sub>A</sub>. Due to higher test costs, these measures would usually not be performed.

With DualMODE™ you can certify the system in compliance with Category 6, and perform tests with the limits of Category 6<sub>A</sub>. Due to unmistakable data, your customer would know exactly what cable lines support higher bandwidths in future applications. This information would be of great importance when making a decision on whether to assemble cables with connectors of a higher category, or to pull in cables of a higher category.

### 5.6.1 Implement DualMODE™

1. Open "Cable Type" on start screen.
2. Use **Arrow Keys** to navigate to function *Twisted Pair DualMODE™* and confirm with **Enter**.

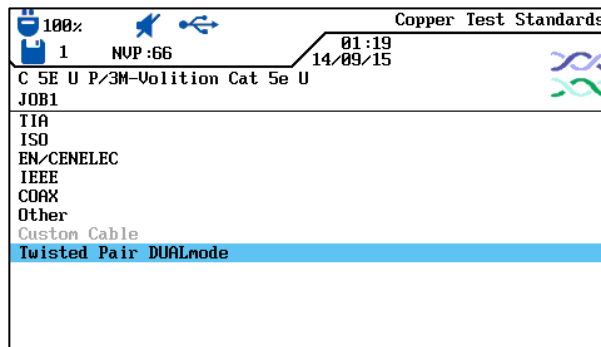

Fig. 51 Twisted Pair DualMODE™

3. Use **Arrow Keys** to navigate to desired cable types. Use soft key **Select** to enable, and soft key **Deselect All** to disable your selection. An enabled pairing is indicated by the green box.
4. If you would like another link model, or edit and calculate NVP for the DualMODE™ pairing, press **Shift**.



5. Press **AUTOTEST**. The passed/failed results are displayed. For each DualMODE™ test, the worst case margins and values for NEXT, RL, ACR und Loss are indicated.

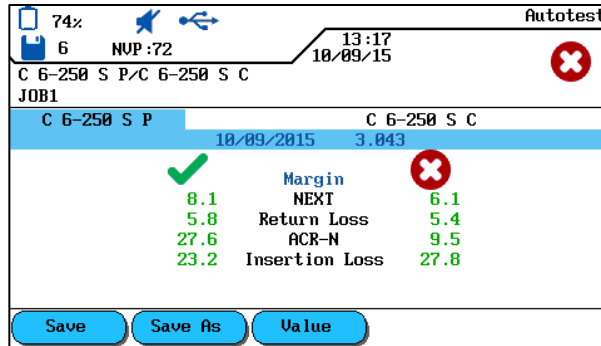

Fig. 52 Overall DualMODE™ Result

6. Use **Enter** to load the corresponding graphical result displays of the highlighted test.



### 5.7 Edit NVP Default Value of a Cable

To perform length measurement, the nominal velocity of propagation (NVP) of the cable must be known. This value can be found in the technical cable information. If this information is not available, a cable of known length (ca. 30 - 60 meter) should be connected, and the NVP calculated by LanTEK III Cable Tester.

1. Open "Cable Type" on start screen.
2. Use **Arrow Keys** to navigate to desired cable type.

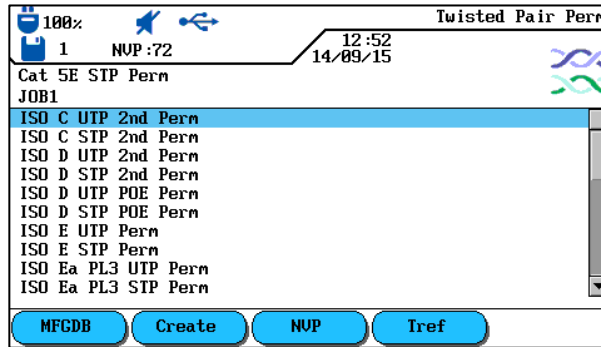

Fig. 53 NVP Default Value

3. Use soft key **NVP** to open menu for entering NVP.

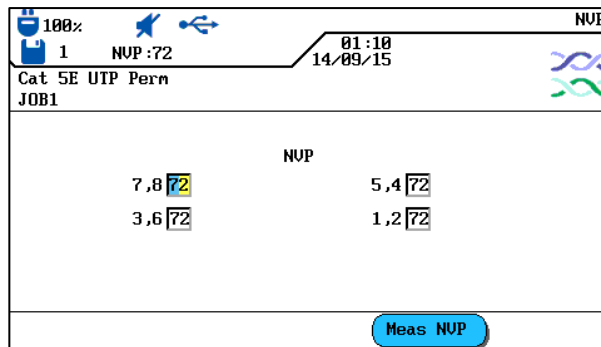

Fig. 54 Enter NVP

4. Use **Alphanumeric keys** to enter one or several NVP.
5. For automatic calculation of a new NVP, press **Meas NVP**.

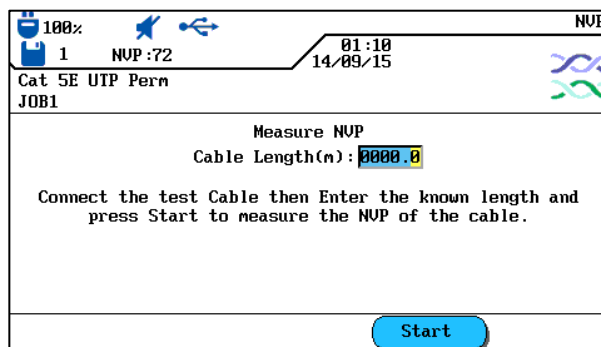

Fig. 55 Calculation of NVP



6. Connect a cable of known length.
7. Use **Arrow Keys** and **Number Keys** to enter known cable length.
8. For automatic calculation of a new NVP, press **Start**. After calculation of new NVP, the display returns to the NVP main screen.

**NOTE:**

**This concerns a channel measurement. When entering the cable length, the length of both patch cords must be considered.**

### 5.8 Coaxial Cable Standards

The LanTEK III Cable Tester supports the following coaxial cable standards:

CATV standards	Ethernet standards	Other cable types
RG59 31 or 92 m (3-fold or 4-fold shield)	10Base 2	IBM Coax
RG6 31 or 92 m (3-fold or 4-fold shield)	10Base 5	TWINAXIAL ARCNET

1. Open "Cable Type" on start screen.
2. Use **Arrow Keys** to navigate to option *Ethernet* and confirm with **Enter**.

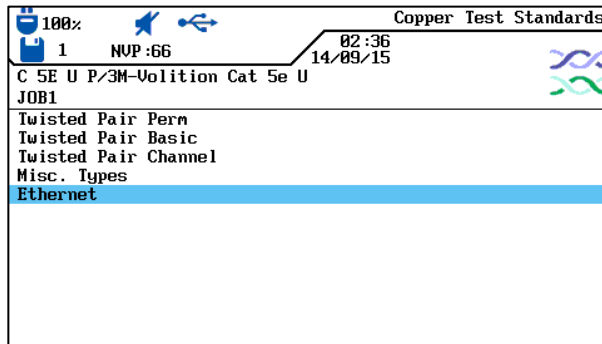

Fig. 56 Ethernet

3. Use **Arrow Keys** to navigate to desired cable type and confirm with **Enter**.

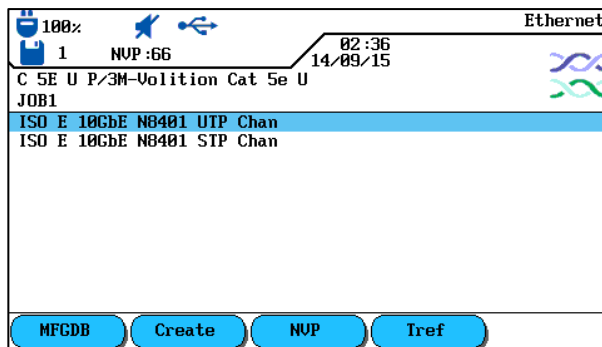

Fig. 57 Cable Type





### 5.8.1 Autotest Test Series for Coaxial Cables

Cable Types	Resistance	Length	Loss	Return loss	Impedance
RG59 31 or 92 m	X	X	X	X	X
RG6 31 or 92 m	X	X	X	X	X
IBM Coax	X	X	X		
TWINAX, ARCNET	X	X	X		
10BASE2 (IEEE 802.3)	X	X	X		
10BASE5 (IEEE 802.3)	X	X	X		

## 5.9 Calibration

A field calibration must be performed if:

- During the last 7 days no calibration has been performed. The user receives a message, informing him that a field calibration is required.
- The test adapter has been changed.
- A patch cord has been changed.
- Note that field calibration is not necessary for CAT6<sub>A</sub> Permanent Link adaptors.

### 5.9.1 Twisted Pair Cabling

1. Use **Arrow Keys** to navigate to "Calibration" and press **Enter** to open job list.

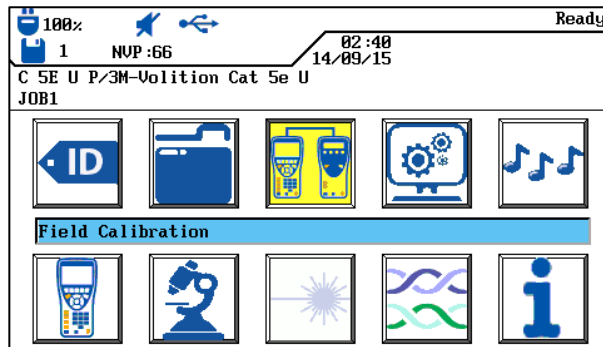

Fig. 58 Ready screen

Calibration requires one patch cord each for the Display handset (DH) and the Remote handset (RH).

**NOTE:**

**It is imperative not to mix up the corresponding patch cords for Display handset (DH) and Remote handset (RH), and they must also be used for the cable test. We recommend to mark the patch cords accordingly.**



13. Connect Display handset (DH) and Remote handset (RH) with patch cord for Remote handset (RH), as shown on the display. Remember which connection of the patch cord is connected to the Remote handset (RH).

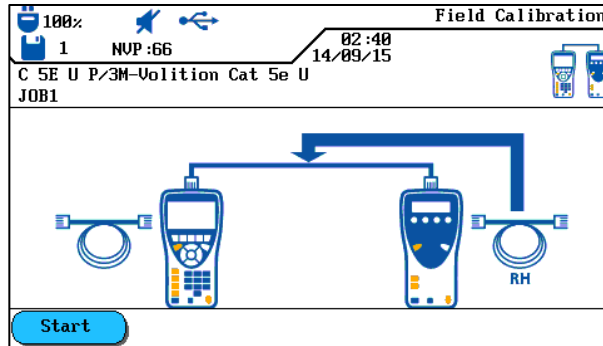

Fig. 59 Patch Cord (RH)

14. Use soft key **Start** to initiate calibration. The Remote handset (RH) indicates calibration, and a progress bar shows the status.
15. Connect Display handset (DH) and Remote handset (RH) with patch cord for Display handset (DH), as shown on the display. Remember which connection of the patch cord is connected to the Display handset (DH).

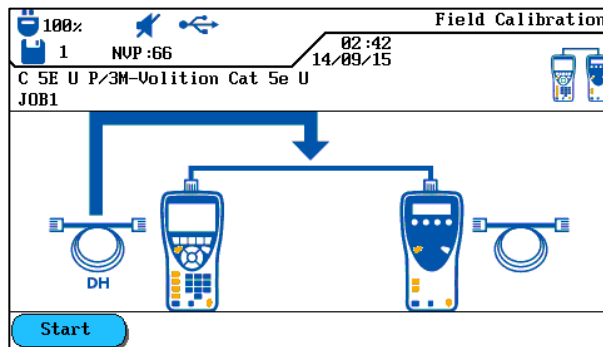

Fig. 60 Patch Cord (DH)

16. Use soft key **Start** to continue calibration. The Remote handset (RH) indicates calibration, and a progress bar shows the status.
17. Perform the same patch cord connections to Display handset (DH) and Remote handset (RH) as during the previous test steps.

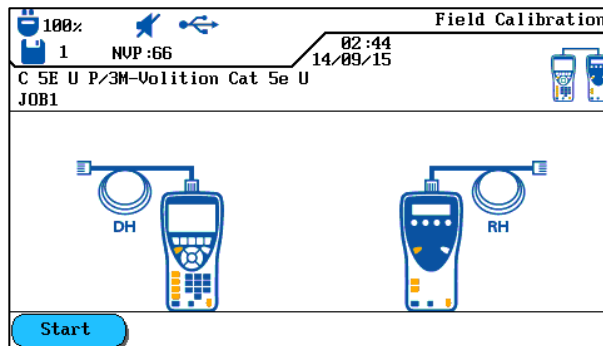
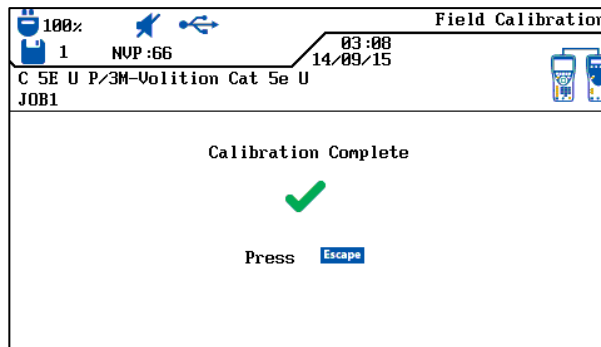

Fig. 61 Open Patch Cord



18. On Display handset (DH) use soft key **Start** to start the last step of calibration.
19. On Remote handset (RH) use **Autotest** to start the last step of calibration.



**Fig. 62 Calibration Complete**

20. On Display handset (DH) press **Escape** to return to screen. The Remote handset (RH) briefly displays that calibration was successful, and then shows ready state.

## 5.9.2 Coaxial Cable

Calibration must be performed if:

- During the last 7 days no calibration has been performed. The user receives a message, informing him that a field calibration is required.
- The test adapter has been changed.
- A patch cord has been changed.

For calibration with COAX adapters, the LanTEK<sup>III</sup> process, consisting of 4 steps, is changed. Since the coaxial cables are tested at low frequencies, the additional data received during calibration are largely ignored, thus calibration with LanTEK<sup>III</sup> Cable Tester is already completed after one step.

### NOTE:

**The LanTEK<sup>III</sup> Cable Tester COAX adapters are equipped with BNC connections. COAX cables applied by the user must convert from/to BNC and F (CATV) or other plug types.**

1. Open "Cable Type" on start screen.
2. Use **Arrow Keys** to navigate to option *Ethernet* and confirm with **Enter**.
3. Use **Arrow Keys** to navigate to desired cable type and confirm with **Enter**.
4. Connect Coax adapters to Display handset (DH) and Remote handset (RH).
5. Connect the short coaxial calibration cable to the adapters of Display handset (DH) and Remote handset (RH).
6. Use **Arrow Keys** to navigate on ready screen to "Calibration" and press **Enter**.

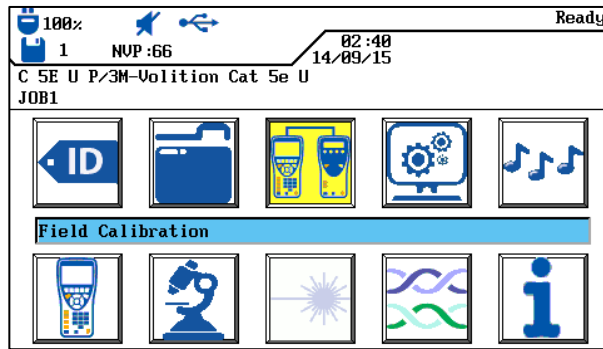

Fig. 63 Ready Screen

7. Use soft key **Start** to initiate calibration.

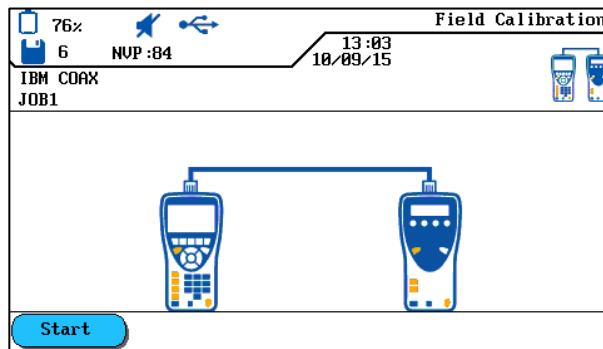

Fig. 64 Coaxial Cable Calibration

8. After completion of calibration and display of according message, press **Escape** to return to main screen.



## 5.10 Perform Autotest

Autotest is performed after all preferences have been carried out.

1. Disconnect the cable line to be tested from all network components.
2. Using suitable patch cords, connect the Display handset (DH) to one end of the cable line (link), and the Remote handset (RH) to the opposite end of the cable line (link).
3. Start by pressing **Autotest**.

## 5.11 Open Job Folder of Autotest

The internal memory of LanTEK'III Cable Tester can hold a maximum of 1700 individual TIA CAT-6 Autotest results with graphs, which can later be loaded again via *File* . The Autotest results can be saved immediately after the test.

- The complete set of test results is saved in a file.
- The test results are automatically saved if Autosave option is enabled.
- Completed tests are automatically assigned a name. If another name is desired, the test can be renamed via option *Rename*.



### 5.11.1 Job Options

1. Open "File" on start screen.
2. Use **Arrow Keys** to navigate to the desired job folder. The display is highlighted yellow.
3. Use soft key  to open job options.

Job Options	Description
Current Job Info	The display shows the total number of passed/failed tests, cable length and memory used for the highlighted job folder.
All Job Info	The display shows the total number of passed/failed tests, cable length and memory used for all highlighted job folders.
Permanently Delete Selected Jobs	The selected job folder is deleted.
Rename Job	Renaming highlighted job folder.
New Job	Adding a new job folder to job list.
Make Job Current	Enables highlighted job folder. Autotests are now stored under this job.



### 5.11.2 Test Options

1. Use **Arrow Keys** to navigate to the desired job folder. The display is highlighted yellow.
2. Press **Enter** to display single tests.
3. Use soft key  to open Test Options.

Test Options	Description
Select all	Selects all stored test results.
Select All Passed	Selects only passed tests for editing.
Select All Failed	Selects only failed tests for editing.
Deselect All	Deselects all stored test results.
Permanently Delete Selected Tests	Deletes highlighted test results.
Permanently Delete All	Deletes all stored test results.

Test Options	Description
Results Info	Displays information on test results, such as number of tests, number of passed/failed tests. Tested lengths and memory used.
Selected Results Info	Displays results of selected tests.
Rename Test	Renames selected test results.

### 5.11.3 Copy Job Folder to USB Removable Storage

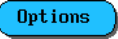
1. Insert the USB removable storage into the USB port of Display handset (DH).
2. Navigate in job list with **Arrow Keys** to job folder to be copied, and highlight it with soft key  (it is possible to highlight several job folders).
3. Use soft key  to open job options.
4. Navigate with **Arrow Keys** to *Copy Selected Jobs to USB Flash Drive* and press **Enter**.

### 5.11.4 Alien Crosstalk Measurements (AXT)

Use soft key  in display of job list to open the saved Alien Crosstalk Measurements and to copy them to a USB removable storage.



### 5.12 Autotest Results and Graphs

The Autotest results can be displayed as table or graph.

1. Open "File" on start screen.
2. Use **Arrow Keys** to navigate to the desired job folder. The display is highlighted yellow.
3. Use **Arrow Keys** to navigate to desired single test. The display is highlighted yellow.
4. Press **Enter** to display overview of single tests.

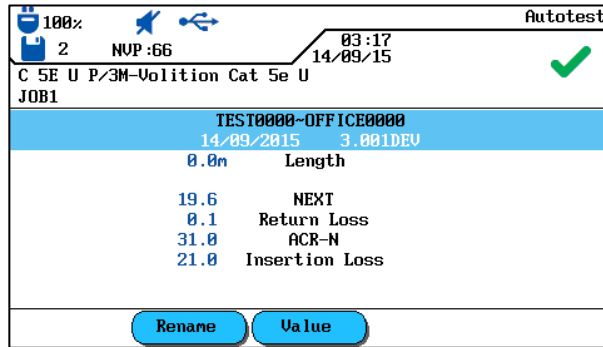

Fig. 65 Single test overview

5. Press **Enter** again to open test series of single test.

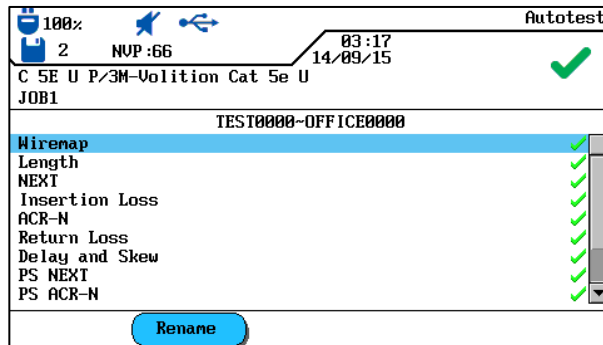

Fig. 66 Test series

6. Use **Arrow Keys** to navigate to desired test series and press **Enter** to display result table.

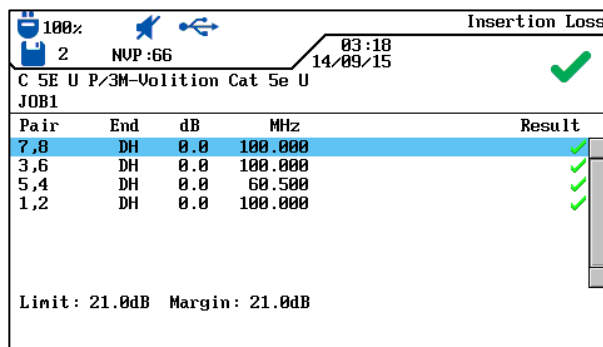

Fig. 67 Result Table





- 7. Use **Arrow Keys** to navigate to desired test result and press **Enter** to display graph.

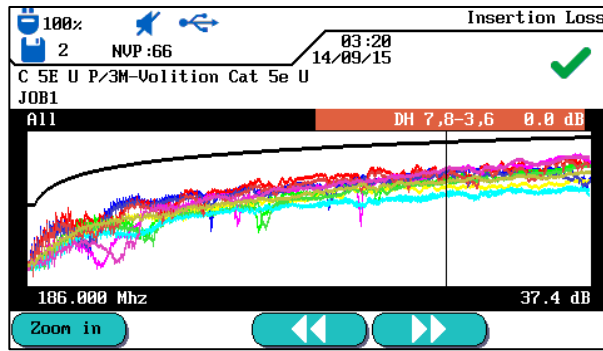

Fig. 68 NEXT Graph

When opening graph, cursor is always in worst case margin. In this example, cursor is positioned on horizontal axis at 186 MHz.

- 8. Press **Escape** to return to previous screen.

### 5.12.1 Graph Formats, Layouts and Controls

Graphs make it easier to recognize the relation between two network parameters, the actually measured values and the pre-programmed limits.

The horizontal axis indicates the frequency values and the vertical axis the measured values in dB. The limits are drawn as solid line.

#### Table view

Pair	End	dB	MHz	Result
7,8	DH	0.0	100.000	✓
3,6	DH	0.0	100.000	✓
5,4	DH	0.0	60.500	✓
1,2	DH	0.0	100.000	✓

Limit: 21.0dB Margin: 21.0dB

#### Graph view

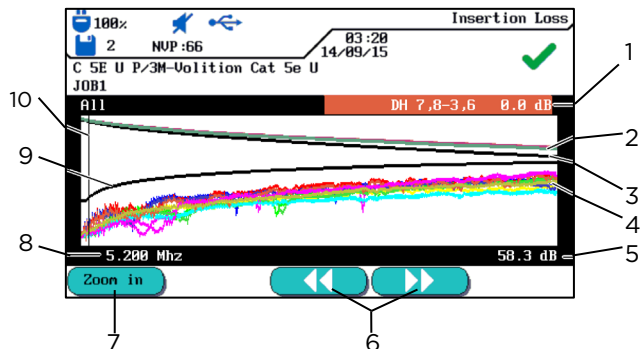



Fig. 69 Table View and Graph View

The margins indicated at lower right in table view provide information on worst case distance between the actual measuring values and the specified limits, as shown by the cursor position in the graph on the right.

	Description
1	Wire pair, plotted on the basis of the table data.
2	Specified limit curve for worst case loss value.
3	The actual measurement curve of the wire pair. In this case, the loss is displayed.
4	The actual measurement curve of the wire pair.
5	Vertical axis with measuring values in dB.



6	<p>Use arrow keys to move cursor horizontally. When cursor position is changed, the measuring values displayed on screen are changed as well.</p> <p>Use soft keys  and  to move cursor in larger steps.</p> <p>Use <b>Arrow Keys</b> to move cursor in smaller steps.</p> <p>While <b>SHIFT</b> key is pressed, cursor can be moved in large steps with <b>Arrow Keys</b>.</p>
7	<p>Enlargement or reduction of view of horizontal axis. At maximum size, these keys have no function.</p>
8	<p>Horizontal axis with frequency values.</p>
9	<p>Specified limit curve for worst case NEXT value.</p>
10	<p>During initial display of wire pair graph, the cursor is automatically at worst case limit and frequency location.</p>



## Chapter 6. Structured Cabling Testing

### 6.1 Test Setup for Single Test Analysis

- Perform calibration if LanTEK®III Cable Tester has not been calibrated during the last 7 days.
- Select cable type.
- Separate cable line to be tested from all network components.
- Connect adapter and patch cord to Display handset (DH) and Remote handset (RH).
- Connect patch cord of display handset (DH) to one end of the cable line and the patch cord of remote handset (RH) to the other end.

### 6.2 Test Run of Single Test Analysis

When performing an analysis test, the following sequences are initiated:

- If test requires Remote handset (RH), the Display handset (DH) initially attempts to establish a connection to the Remote handset (RH). If connection cannot be established, the Display handset (DH) will show the message "Searching for Remote (RH)". The search is continued until the analysis test is manually cancelled or the Remote handset (RH) is located.
- After connection to the Remote handset (RH) has been successfully established, its serial number is read out to check if current configuration data are available. If during the last 7 days no calibration has been performed on the identified Remote handset (RH), the user receives a message that calibration is recommended.
- Display handset (DH) continues the selected single test if serial number is valid.
- If test does not require a Remote handset (RH), the Display handset (DH) performs the test and displays the result.

**NOTE:**

**When pressing Escape, the Display handset (DH) stops Searching for Remote (RH) and initiates the test under conditions that do not require a Remote handset (RH).**

- Once test is completed, the results can be displayed or printed.
- 

### 6.3 Perform Single Test Analysis

1. Connect Display (DH) and Remote (RH) handset to cable line that is to be tested.
2. Open "Analyze" on start screen.
3. The tests available for the selected cable type are displayed.
4. Use **Arrow Keys** to navigate to desired test.

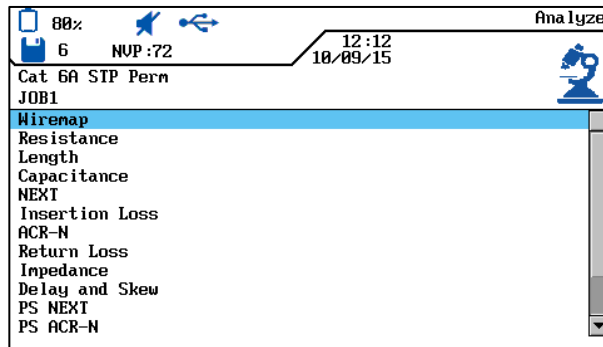
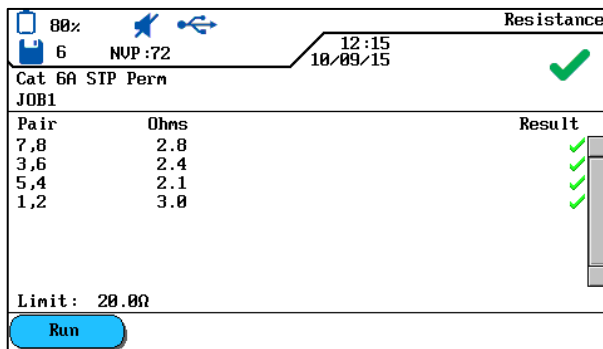

Fig. 70 Single Tests

- 5. Confirm selection of test with **Enter**. After completion of test, a result table opens.

### 6.4 Evaluation of Analysis Test Results

The overall result of the analysis test is displayed in the upper right on the screen below the title bar. The results for the individual wire pairs are displayed on the right side of the respective test.



Overall result

Individual Results

Fig. 71 Evaluation of Analysis Test Results

The above example shows the screen for DC resistance.

- The overall result of the test appears in the upper right, beside the date.
- The results of the individual wire pairs appear in the last column on the right (result column).

The results for the overall test and the single tests are indicated similar to Autotest.

#### 6.4.1 Graphs for Analysis Tests

After completion of test series, certain analysis results can be displayed in table or graph format. The graph display in analysis mode is comparable to the one of Autotest.



## 6.5 Overview of Single Test Analysis

Analysis mode allows fault repair by performing single tests, making changes and displaying changed test results. With the analysis test it is possible to check the cable continuously for damage or overstretching.

Depending on cable type and specified test standard, the following single test analyses are available:

Wiremap	Resistance	Length
Capacitance	NEXT	Loss/Insertion Loss
ACR-N (ACR)	Return loss	Impedance
Delay and Skew	Power Sum NEXT	Power Sum ACR-N (Power Sum ACR)
Margin	ACR-F (ELFEXT)	Power Sum ACR-F (Power Sum ELFEXT)

**NOTE:**

**The following tests do not require a Remote handset (RH): Resistance, Length, Capacitance, Impedance, Delay and Skew.**

## 6.6 Wiremap Test

With the aid of Wiremap tests it is possible to pinpoint short circuits, interrupts and incorrect wiring. To facilitate evaluation, the test results are displayed in graph format.

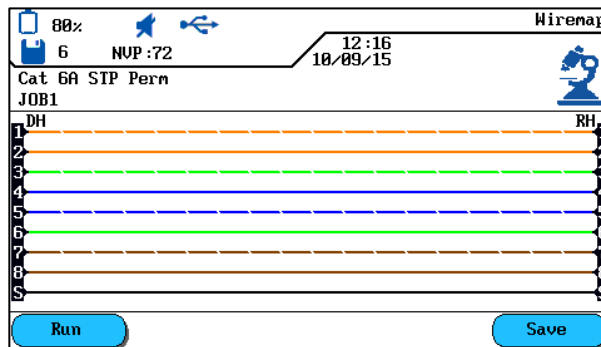

**Fig. 72 Wiremap Test**

An error indicated by the Wiremap test should always be corrected first, since it will cause errors in other tests. An unwired contact can cause the tests for DC loop resistance and loss to receive a failing grade as well. An interrupt can also lead to a zero result when testing capacitance, resulting in failed NEXT measuring values.

The Wiremap test ensures the following minimum thresholds for fault recognition (based on four wire pairs, optional shield):

- All Wiremap errors or combined Wiremap errors are indicated as errors in the Wiremap diagram.
- All combinations of up to three interrupts, short circuits or reversed connections are correctly detected.
- In case of interrupts and short circuits, the cable end at which the error occurred is indicated (on Autotest screen for length measurement).



- Split wire pairs (Split Pairs) are detected by specific patterns of contradictory NEXT values (Near End Cross-Talk).

## 6.7 Length Test

This test determines the length of wire pairs to ensure that the recommended limits for the selected cable are complied with. Depending on the measurement unit selected in "Preferences", the length is indicated in Foot or Meter.

Pair	NUP	ft	Result
7,8	0.72	75.1	✓
3,6	0.72	74.1	✓
5,4	0.72	74.5	✓
1,2	0.72	74.8	✓

Limit: 0.0 ft - 295.3 ft

Run

Fig. 73 Length Test

### 6.7.1 Length Test Error

Minor length differences can occur between the wire pairs of a cable due to small NVP differences, as well as length differences caused by transposition. A failure exists if the electronically measured cable length deviates too much from the actual length.

## 6.8 Resistance Test

This test determines the loop resistance of the individual wire pairs. This ensures that the total loop resistance does not exceed the recommended limits. For each wire pair, the results are displayed as resistance value in ohm, together with the reference limit for the cable type.

Pair	Ohms	Result
7,8	2.8	✓
3,6	2.4	✓
5,4	2.1	✓
1,2	3.0	✓

Limit: 20.0Ω

Run

Fig. 74 Resistance Test



### 6.8.1 Resistance Test Error

All four wire pairs of a transmission line within the network should have approximately the same resistance. If the resistance value of a wire pair exceeds the limit, the test is considered failed.

### 6.9 NEXT, ACR-F (ELFEXT) and Power Sum

In an Autotest, crosstalk at the near and far end of the cable is measured with NEXT (Near End Cross Talk) and ACR-F (ELFEXT) tests. High crosstalk levels can result in frequent recurrences, damage to data and other interferences that impair transmission rate.

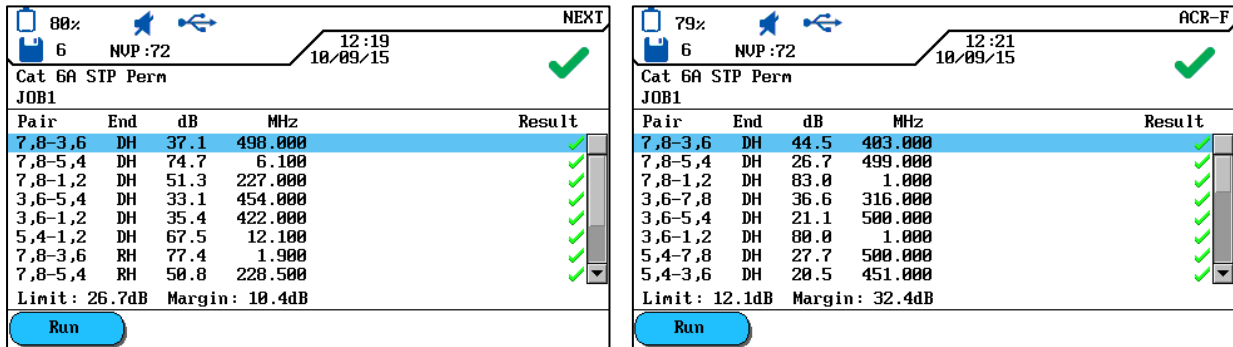

Fig. 75 NEXT, ACR-F (ELFEXT) and Power Sum

The NEXT test determines interfering effects (crosstalk) of a transmitting wire pair on the adjacent wire pair in the same cable. NEXT is measured on Display handset (DH) and Remote handset (RH).

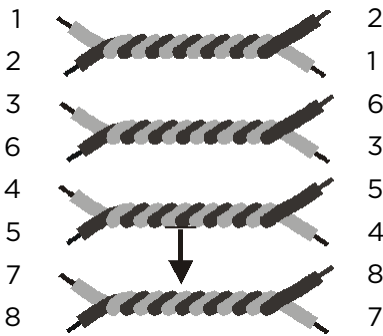

Fig. 76 Effect of Adjacent Pair

- FEXT test and NEXT measurement are similar; the only difference is that in FEXT test the transmissions emanate from Remote handset (RH) and that crosstalk is determined at Display handset (DH).
- NEXT measurements are performed on each cable end and for all wire pair combinations (pair 1-2 to 3-6 etc.). Thus, a total of 12 measurements is performed.
- ACR-F (ELFEXT) measurements take place with the Display handset (DH) and the Remote handset (RH) on both cable ends and for all possible wire pair



combinations (1-2 to 3-6, 3-6 to 1-2, 1-2 etc.). This results in a total of 12 measurements.

### 6.10 Power Sum NEXT, Power Sum ACR-F (ELFEXT)

Power Sum-Tests determine the crosstalk effects of three transmitting wire pairs on the fourth wire pair in the same cable.

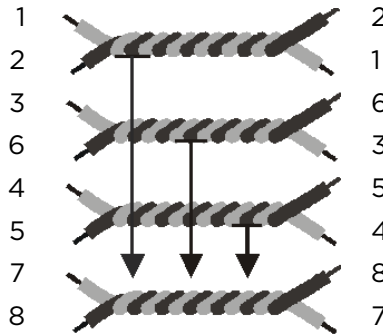

Fig. 77 Effects of 3 Pairs on 1 Pair

When using Power Sum NEXT, four (4) calculations on each cable end and on each wire pair combination (pairs 1-2, 3-6 and 4-5 to 7-8 etc.) are performed. A total of eight (8) values is obtained.

Pair	End	dB	MHz	Result
7,8	DH	35.4	499.000	✓
3,6	DH	32.0	422.000	✓
5,4	DH	32.8	454.000	✓
1,2	DH	35.2	422.000	✓
7,8	RH	75.5	1.750	✓
3,6	RH	38.8	376.000	✓
5,4	RH	42.6	346.000	✓
1,2	RH	38.7	376.000	✓

Limit: 23.8dB Margin: 11.6dB

Run

Fig. 78 Power Sum NEXT

**NOTE:**

**The Power Sum NEXT values are usually 2 - 3 dB below the value (= stronger crosstalk) than with conventional NEXT measurement.**

When using Power Sum ACR-F (Power Sum ELFEXT), four (4) calculations on the side of the Display handset (DH) and on each wire pair combination (pairs 1-2, 3-6 and 4-5 to 7-8 etc.) are performed. A total of eight (8) values is obtained.





Pair	End	dB	MHz	Result
7,8	DH	26.0	499.000	✓
3,6	DH	21.1	500.000	✓
5,4	DH	20.2	451.000	✓
1,2	DH	79.0	1.000	✓
7,8	RH	27.3	499.000	✓
3,6	RH	20.2	451.000	✓
5,4	RH	19.9	499.000	✓
1,2	RH	70.4	1.000	✓

Limit: 7.2dB Margin: 18.0dB

Fig. 79 Power Sum ACR-F (Power Sum ELFEXT)

### 6.10.1 NEXT Test and ACR-F (Power Sum ELFEXT) Test Error

Crosstalk is usually caused by faulty connections at the cable ends. The lower the measuring values in dB, the stronger the crosstalk.

### 6.11 Insertion Loss Test (Attenuation)

This test determines the overall insertion loss of the signal in the cable and checks compliance with limits. A minor loss is the prerequisite for a faultless transmission. Insertion loss measurement is performed by feeding a signal with known amplitude into the Remote handset (RH) and then reading the amplitude on the Display handset (DH).

Pair	End	dB	MHz	Result
7,8	DH	12.2	487.000	✓
3,6	DH	12.4	494.000	✓
5,4	DH	12.7	499.000	✓
1,2	DH	12.2	485.000	✓

Limit: 43.1dB Margin: 30.9dB

Fig. 80 Loss Test

### 6.11.1 Insertion Loss test Error

The insertion loss reduces the signal in the cable. Loss increases with cable length, signal frequency and temperature. With the aid of loss tests it is possible to detect faults in cable, connections and connection technology. A high loss value in dB indicates a strong loss, and thus a higher signal reduction.

### 6.12 Return Loss Test

This test determines the relation between reflected and transmitted signal amplitude. High-grade cable lines exhibit only minor reflection, thus demonstrating a good impedance adjustment of the individual components connected to the cable.



Return Loss				
79%	6	NUP:72	12:25	10/09/15
Cat 6A STP Perm				
JOB1				
Pair	End	dB	MHz	Result
7,8	DH	17.2	394.000	✓
3,6	DH	14.1	374.000	✓
5,4	DH	19.2	346.000	✓
1,2	DH	28.8	25.900	✓
7,8	RH	25.4	21.550	✓
3,6	RH	25.5	39.750	✓
5,4	RH	21.8	176.500	✓
1,2	RH	25.6	44.000	✓
Limit:		8.0dB	Margin:	9.2dB
<input type="button" value="Run"/>				

Fig. 81 Return Loss Test

### 6.12.1 Return Loss Test Error

Same as with loss, an excessive return loss also results in signal reduction at the reception end. It also indicates that an impedance mismatch exists in a section of the cable. A value of 20 dB or higher indicates a good twisted-pair cable.

### 6.13 Impedance Test

The average impedance is calculated from delay of electrical signal and capacitance measurement. The result is indicated in ohm. The average impedance can help in identifying damages to cable, connections or cable sections with impedance mismatch.

Since this test uses a capacity measurement, the correct cable type must be indicated to obtain a precise measuring result.

**NOTE:**

The measurements are incorrectly calculated if the setting is for a type CAT 3 cable (the cable insulation containing PVC), but the test is actually performed on a CAT 5 cable (insulation containing Teflon®). Therefore, ensure that the correct cable type is selected.

Impedance			
79%	6	NUP:72	12:26
Cat 6A STP Perm			
JOB1			
Pair	Ohms	Result	
7,8	171.5	✗	
3,6	154.2	✗	
5,4	148.8	✗	
1,2	149.8	✗	
Limit:		85.0 - 115.0 Ω	
<input type="button" value="Run"/>			

Fig. 82 Impedance Test

### 6.13.1 Impedance Error

Impedance errors cause signal reflections and signal reduction. Average impedance of wire pairs should comply with LAN system impedance of 100, 120 or 150 Ω.



### 6.14 Delay and Skew Test

This test determines the delay of a test signal that was fed at one end of the cable to the other end of the cable. The delay skew indicates the difference between the measured delay of the corresponding wire pair and the wire pair with the lowest delay value. The limits specified for delay and skew depend on selected cable type.

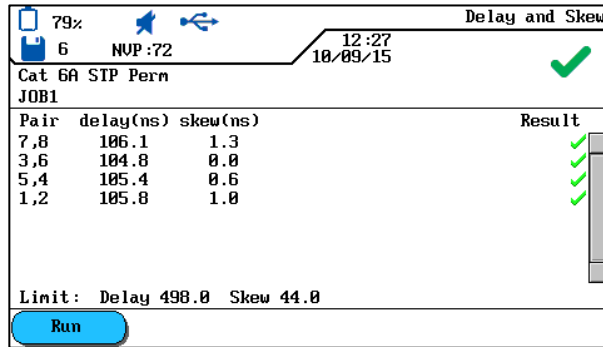

Fig. 83 Delay and Skew Test

#### 6.14.1 Delay and Skew Test Error

The delay and skew measurements usually result in slightly different values for the individual wire pairs of a cable. However, a large difference indicates a cable fault or a damaged wire pair.

### 6.15 Capacitance Test

This test determines the mutual capacitance between the two conductors of each wire pair, to ensure that the capacitance of the corresponding cable type has not been impaired by the installation.

- The capacitance test of the analysis mode indicates the overall capacitance in Nanofarad (nF).
- The Autotest measures the overall capacitance in Picofarad (pF) per meter or foot.

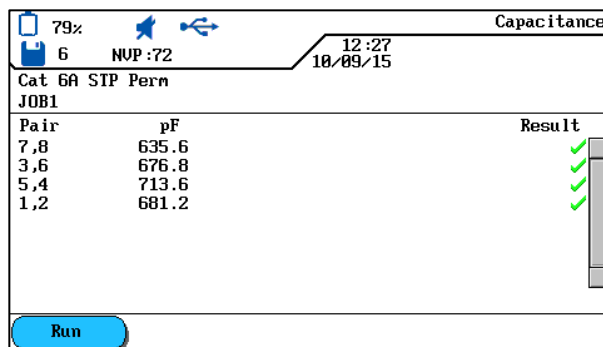

Fig. 84 Capacitance Test



### 6.15.1 Capacitance Test Error

The higher the capacitance, the higher the error rate. Due to transport and installation of the cable, minor changes in capacitance are normal. Connectors and patch cords also influence capacitance values.

### 6.16 ACR-N (ACR) Test and Power Sum ACR-N (Power Sum ACR) Test

The ACR-N (ACR) test determines the loss-crosstalk distance by means of a mathematical comparison (difference calculation) of the loss and NEXT test results. The differences between the measuring values of a wire pair indicate whether transmission interferences are likely to occur in the respective wire pair.

The ACR-N (ACR) measurement is calculated from pair to pair. Power Sum ACR-N (Power Sum ACR) measurement is calculated by summation of NEXT values between a selected wire pair and three other wire pairs of the same cable.

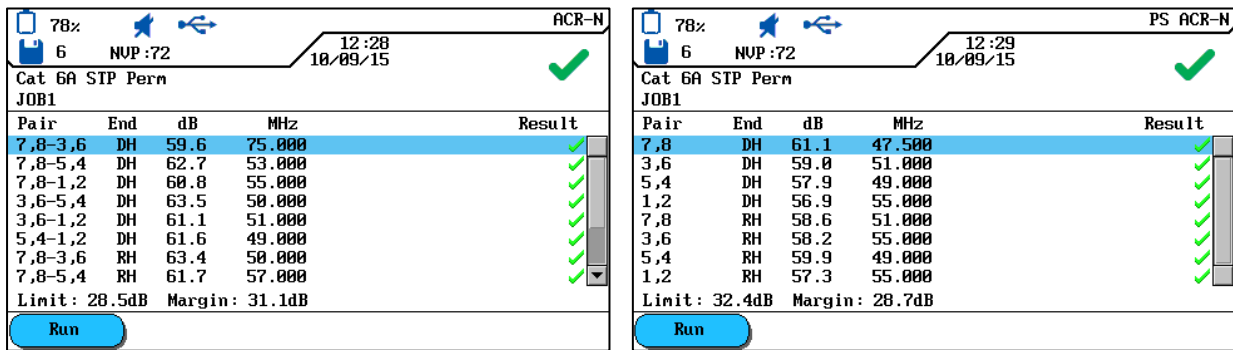

Fig. 85 ACR-N (ACR) / Power Sum ACR-N (Power Sum ACR)

### 6.16.1 ACR-N (ACR) Test and Power Sum ACR-N (Power Sum ACR) Test Error

A large difference between the measuring values is preferable, since this indicates a strong signal and minor perturbations.

### 6.16.2 Troubleshooting ACR-N (ACR) Test and Power Sum ACR-N (Power Sum ACR) Test Error

For information on troubleshooting, refer to the corresponding sections on NEXT and loss test.

### 6.17 Headroom Test

The headroom test is a mathematical analysis of the data calculated during the preceding test. The sum of Power Sum ACR-N (Power Sum ACR) test (i.e. corresponding value of worst case wire pair after normalization of wire pair loss over 100 meters) and the additional margin between the worst case Power Sum NEXT-value and the limit for Power Sum NEXT.



The headroom test is a simple way to indicate the margins available on a cable line for faultless support of an application. This test also indicates the additional margin obtainable by using "improved" cables and connections, as well as careful installation.

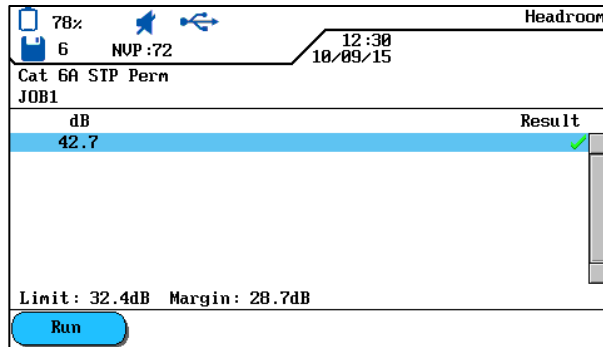

Fig. 86 Margin Test

### 6.17.1 Headroom Test Error

The headroom value indicated in dB identifies the minimum margin available for a cable line. A high value is preferable, since it indicates a strong signal and minor perturbations. The pass/fail limits for the margin are identical with those for Power Sum ACR-N (ACR).

## 6.18 Custom Cable Preferences and Cable Parameters

All cable types pre-programmed in LanTEK III Cable Tester are based on a predefined test standard. These pre-programmed preferences cannot be changed. If you wish to perform other tests on a selected cable line, you first must create a custom cable.

Example: In addition to TIA 568B Category 5 tests, the return loss is to be measured (which is not required by TIA). For this purpose, a custom cable is created and the tests selected that are to be included in the test series for this cable.

A maximum of ten (10) custom cables can be created, stored, deleted and, if required, loaded.

### 6.18.1 Creating a New Custom Cable Type

1. Open "Cable Type" on start screen.
2. Use **Arrow Keys** to navigate to desired cable type.

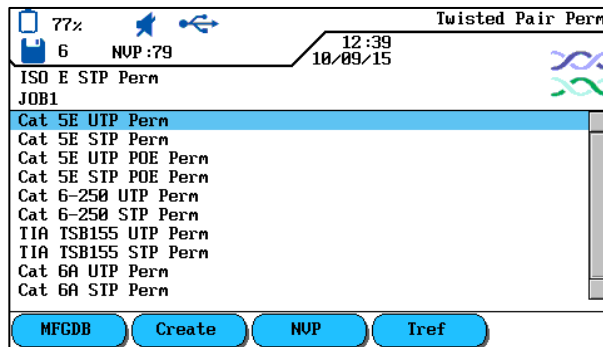

Fig. 87 Cable Type

3. Use the soft key  to open menu selection.

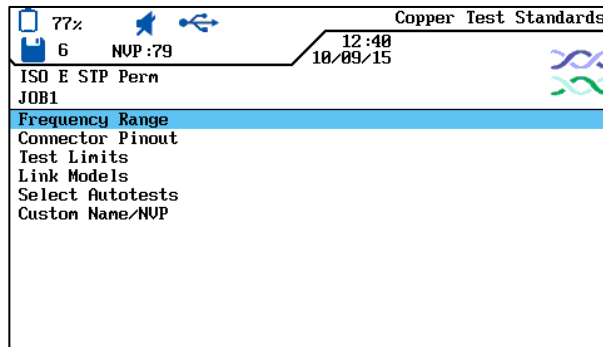

Fig. 88 Menu Selection Test Standards

4. Use **Arrow Keys** to navigate to *Custom Name/NVP* and confirm with **Enter**.

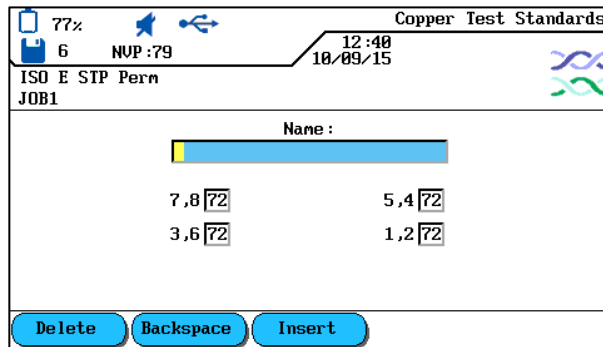



Fig. 89 Custom Name/NVP

5. Assign a name for the newly created custom cable The soft key  appears.
6. Use **Alphanumeric Keys** to enter one or several NVP values, if required.
7. Use soft key  to accept changes and return to screen to create a custom cable.

### 6.18.2 Select Custom Cable Type

The custom cable type can be edited at any time or selected as current cable type.

1. Open "Cable Type" on start screen.
2. Use **Arrow Keys** to navigate to *Custom Cable* and confirm with **Enter**.
3. Use **Arrow Keys** to navigate to desired custom cable type and confirm with **Enter**.



### 6.18.3 Custom Cable Parameters

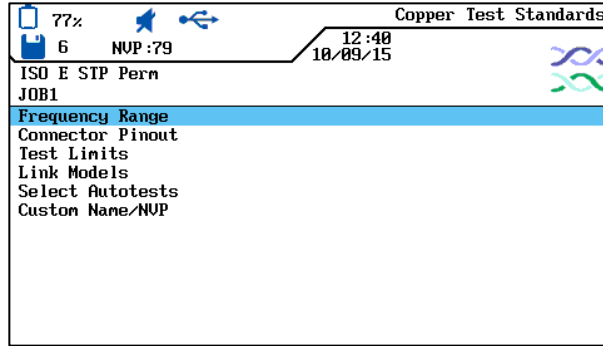

Fig. 90 Custom Cable Parameters

Parameters	Description
Frequency range	Use this menu to set the lowest and highest frequency for certification and evaluation of cable performance.
Connector Pinout	Use this screen to determine the configuration of the contact pins of the plug. <b>Note:</b> <b>Tests for NEXT, loss, capacitance, DC-resistance and impedance cannot be performed on wire pairs that have not been selected.</b>
Test Limits	Use this screen to adjust the pass/fail limits for the Autotest to your requirements.
Link models	The custom limits for NEXT and loss are specified as constant limit or according to the link models. The frequency limits depend on LanTEK <sup>®</sup> III model and link type.
Select Autotests	Not all cable lines require the complete Autotest test series. Use this option to select the individual Autotests to be performed.
Custom Name/NVP	Use <b>Alphanumeric Keys</b> to enter a custom name or edit the NVP value. LanTEK <sup>®</sup> III Cable Tester can save up to 10 custom cable types.



## Chapter 7. Coaxial Cable Test

### 7.1 Properties of Coaxial Cables

The coaxial cable offers numerous benefits. It is hardly influenced by electromagnetic disturbances and supports high bandwidths. Thus, many customers prefer using the coaxial cable for their cable TV and data applications.

A typical coaxial cable consists of:

- **Center Conductor:** This conductor usually consists of a fairly heavy, solid and yet flexible wire. Stranded wire is also used. Though solid conductors are preferred for permanent installation, a cable with stranded wires is more flexible and easier to connect to devices.
- **Insulation:** Also referred to as dielectric layer. It ensures electrical insulation and keeps the inner and outer conductors in precise coaxial alignment.
- **Outer Conductor or Shield:** This layer protects the inner conductor from external electrical perturbations. The shield can consist of wire mesh, metal foil or a combination of both. This shield makes the coaxial cable extremely impervious to electromagnetic disturbances.
- **Sheath:** A robust sheath made of plastic or Teflon protects the coaxial cable from mechanical damage.

Coaxial cables differ by their impedance (in ohm), which indicates the cable's resistance of the current. Thus, a coaxial cable of type RG-59 and RG-6 typically has an impedance of 75 ohm, whereas a RG-58 cable has 50 ohm.

### 7.2 Troubleshooting Coaxial Cables

Use only high-grade connectors and tools to properly seal coaxial cable networks. If cable has an error, check the following failure points:

- **Faulty connection:** Check if neutral conductor is properly separated from shield.
- **Cable Short Circuit:** Could occur if cable has been improperly connected to near and far end. In case of a short circuit, check the resistance values indicated on the tester. A value of 0 (zero) indicates that the fault is located at the near end of the cable, whereas a value of ~ 20 ohm points to the far end.
- **Cable Interruption:** Occurs frequently. In this case, check out the length measurement result. A value of 0 (zero) for cable length points to a fault located at the near end.





## Chapter 8. Tone Generator

The Display handset (DH) as well as the Remote handset (RH) can generate a low tone, a high tone and an alternating tone, with a rate of 2 Hz between low and high alternating tone ("Warble"), which is recognized by most standard cable locators.

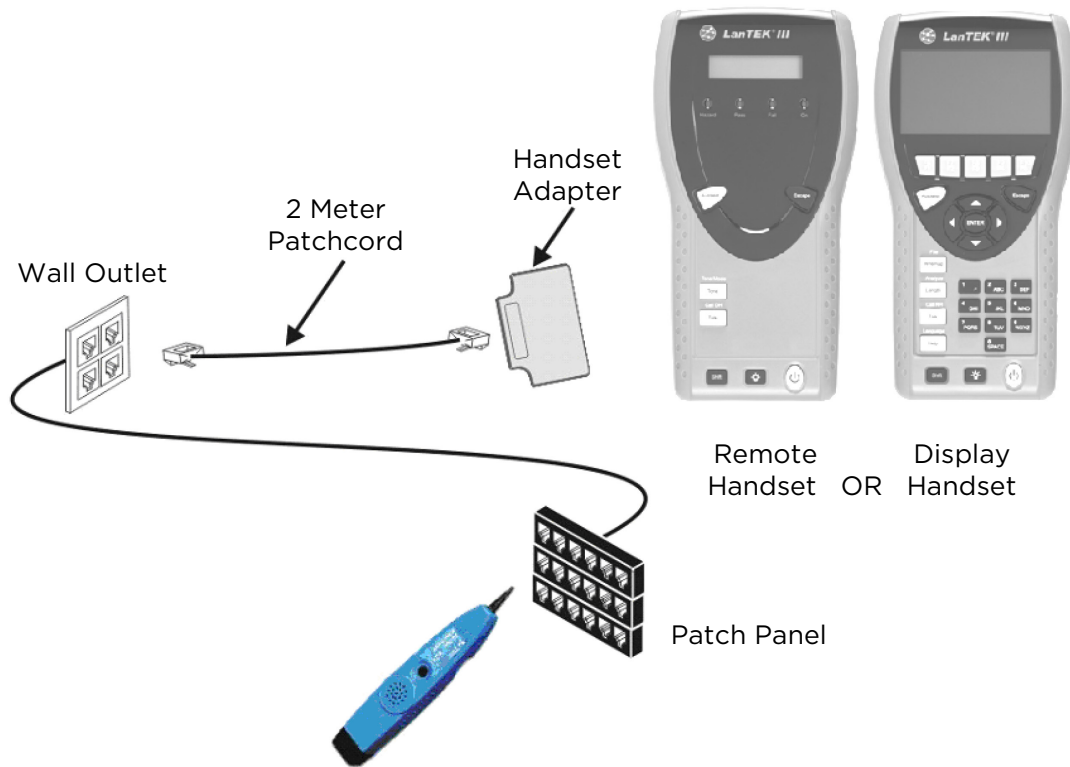

Fig. 91 Typical Application of Tone Generator

**NOTE:**

The keys **WIREMAP**, **SHIFT** and **TONE** are hard keys. The keys **Pair A**, **Pair B**, **Pair C**, **Pair D**, **Low**, **High** and **Warble** are soft keys that are displayed on the Display handset (DH).

### 8.1.1 Enable Tone Generator with Display handset (DH)

1. Connect Display handset (DH) to cable to be tested.
2. Use **Arrow Keys** to navigate on ready screen to "Toner" display and confirm with **Enter**.

**NOTE:**

The **Tone Mode** remains enabled until you press **Escape**.

3. Use soft keys to select the wire pair (Pair 78, Pair 36, Pair 54 or Pair 12) into which the tone signal is to be fed.
4. Press **SHIFT** to select tone signal and enable it with soft keys **LOW**, **HIGH** or **WARBLE**.

### 8.1.2 Enable Tone Generator with Remote handset (RH)

1. Connect Remote handset (RH) to cable to be tested.



2. On Remote handset (RH) press *TONE*. The tone mode is enabled. The first line of the two-line Remote handset (RH) display shows the message *TONE*. In the second line, the type of tone signal as well as the feed location is shown in XY format.

<b>X symbol (Tone)</b>	<b>Y symbol (feed location)</b>
L = Low	78 = Pair 78
H = High	36 = Pair 36
W = Warble	54 = Pair 54
	12 = Pair 12

Example: L78 = low tone ("Low"), pair 78

**NOTE:**

**The Tone Mode remains enabled until you press Escape.**

3. Select the wire pair into which the tone signal is to be fed by switching between the options with the **TONE** key.
4. Select the tone signal for the selected wire pair by switching between the options with **<SHIFT>+TONE**.



## Chapter 9. LanTEK Firmware Upgrade

The firmware of LanTEK® III Cable Tester should be updated in regular intervals. You can download the latest firmware upgrade from the website of IDEAL INDUSTRIES, INC. separately or together with the software update of IDEAL DataCENTER.

If you register for the **Newsletter** on the website of IDEAL INDUSTRIES, INC., you will automatically receive information on new downloads.

### 9.1 Perform Firmware Upgrade

Using a computer, the firmware of LanTEK® III Cable Tester can be updated with the LanTEK Firmware Upgrade program, or without a computer with a USB removable storage.

**NOTE:**

**Before updating the firmware, make a backup of the test records on the LanTEK® III Cable Tester.**

**When updating the firmware, the Display (DH) or the Remote (RH) handset must be supplied with power through the adapter.**

#### 9.1.1 Using the Computer

1. Supply the Display handset (DH) with power by using the adapter.
2. Connect the Display handset (DH) to a free USB port of the computer by using the USB cable supplied with the LanTEK® III Cable Tester.
3. Power the Display handset (DH) on.

4. On the Windows desktop, select the start symbol  **LanTEK Firmware Upgrade**.

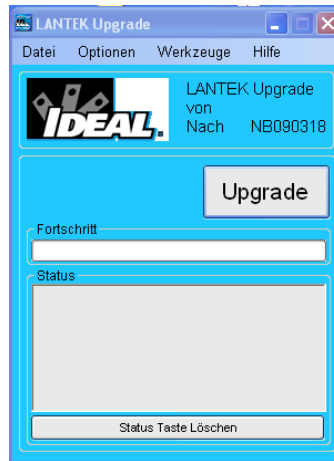

Fig. 92 LanTEK Firmware Upgrade

5. Select **Upgrade** and follow the instructions until the upgrade is finished.

**NOTE:**



**Upgrade only newer firmware with higher end numbers.**

**During the upgrade, the connection to the adapter must not be interrupted.**

6. Repeat with the remote handset (RH).  
or

7. Supply the Remote handset (RH) with power by using the adapter.





8. Connect the Display (DH) and the Remote (RH) handset with a patch cord by using the test adapters.
9. Press **Autotest**. The Display Handset (DH) reports the version difference.
10. Open **Calibration** menu.
11. Enable firmware upgrade with .
12. Confirm update with .
13. Wait until upgrade is finished and normal operating status is displayed on Remote handset (RH).

## 9.1.2 Firmware Upgrade with USB Removable Storage

1. Save the firmware upgrade on an empty USB removable storage.
2. Supply the Display handset (DH) with power by using the adapter.
3. Insert the USB removable storage into the USB port of the powered off Display handset (DH).
4. Power the display handset (DH) on, wait approx. 1-2 seconds, then press and hold the **Escape** button until an hourglass appears on the TFT display. Release the escape button when the hour glass appears.
5. Wait until the upgrade is finished and the main menu appears on the Display handset.

### NOTE:

**During the upgrade, the connection to the adapter must not be interrupted.**

6. Supply the Remote handset (RH) with power by using the adapter.
7. Connect the Display (DH) and the Remote (RH) handset with a patch cord by using the test adapters.
8. Press **Autotest**. The Display Handset (DH) reports the version difference.
9. Open **Calibration** menu.
10. Enable firmware upgrade with .
11. Confirm update with .
12. Wait until upgrade is finished and normal operating status is displayed on Remote handset (RH).



## **Chapter 10. Customer Service**

To comply with precision requirements, you should have your LanTEK'III Cable Tester calibrated on an annual basis. Before sending the tester for calibration or maintenance, please contact the local Technical Customer Service of IDEAL INDUSTRIES at [www.idealnetworks.net](http://www.idealnetworks.net)



**IDEAL NETWORKS**

IDEAL INDUSTRIES LIMITED  
Stokenchurch House, Oxford Road, Stokenchurch,  
High Wycombe, Bucks, HP14 3SX, UK.

**[www.idealnetworks.net](http://www.idealnetworks.net)**

A subsidiary of IDEAL INDUSTRIES INC.



**IDEAL INDUSTRIES, INC.**