

GE  
Measurement and Control  
**Druck DPI612**

Portable Pressure Calibrator

**User Manual – 109M4017**



© 2014 General Electric Company. All Rights Reserved.  
Specifications are subject to change without notice. GE is a registered trademark of General Electric Company. Other company or product names mentioned in this document may be trademarks or registered trademarks of their respective companies, which are not affiliated with GE.

### Revision History

This document supersedes all previously issued versions, providing new or revised information. The most recent publication can be determined by comparing the last three characters at the end of the part number and the date issued.

#### DPI 612 Portable Pressure Calibrator User Manual

**Part Number: 109M4017**

<b>Revision Level</b>	<b>Date Issued</b>	<b>General Description of Changes</b>
Revision -	07/08/15	First Release

## Contents

1	INTRODUCTION .....	8
1.1	EQUIPMENT IN THE BOX .....	8
1.2	OBSERVANCE OF THE USER MANUAL .....	8
1.3	GENERAL SAFETY PRECAUTIONS .....	8
1.4	WARNINGS .....	10
1.5	ELECTRICAL SAFETY .....	10
1.6	RECHARGABLE BATTERY WARNINGS .....	11
1.7	PRESSURE WARNINGS .....	14
1.8	OVERVOLTAGE CATEGORY .....	15
1.9	PREPARING THE INSTRUMENT .....	15
1.9.1	Initial Checks .....	15
1.9.2	Install Rechargeable Battery and Cradle .....	15
1.9.3	Install Dry Cell Batteries .....	17
1.10	PARTS .....	19
1.10.1	DPI 612 .....	19
1.10.2	Test Port .....	21
1.10.3	Pressure Release Valve .....	22
1.10.4	SELECTOR DPI 612 pFlex & pFlexPro (20 & 100 bar) .....	22
1.10.5	Pump .....	22
1.10.6	Volume Adjuster .....	23
1.10.7	Refill Valve .....	25
1.10.8	Priming Pump DPI612 hFlexPro (1000 bar) .....	25
1.11	ACCESSORIES: .....	26
1.11.1	Carry Case (P/N IO612-CASE-3) .....	26
1.11.2	Rechargeable Battery pack (P/N CC3800GE) .....	26
1.11.3	Rechargeable Battery and adaptor kit (P/N IO61X-BAT-KIT) .....	26
1.11.4	Rechargeable Desktop Charger (P/N CX6100GE) .....	26

1.11.5	Mains Adaptor (P/N IO620-PSU) .....	26
1.11.6	USB Cable (P/N IO620-USB-PC).....	27
1.11.7	IDOS to USB Converter (P/N IO620-IDOS-USB).....	27
1.11.8	USB to RS 232 Cable (P/N IO620-USB-RS232).....	27
1.11.9	Dirt Moisture Trap 20 bar (P/N IO620-IDT621).....	27
1.11.10	Dirt Moisture Trap 100 bar (P/N IO620-IDT622).....	27
1.11.11	Pneumatic Hose (PN IO620-HOSE-P1 / IO620-HOSE-P2).....	28
1.11.12	Hydraulic Hose (PN IO620-HOSE-H1 / IO620-HOSE-H2).....	28
1.11.13	Low Pressure Pneumatic Hose (PN IOHOSE-NP1 / IOHOSE-NP2) ..	28
1.11.14	Pressure Adaptor set .....	29
1.11.15	Comparator Adaptor (P/N IO620-COMP).....	29
1.11.16	Pressure Module (P/N IPM620-***).....	29
1.11.17	Pressure Relief Valve (PRV).....	30
1.12	DRUCK DPI612, MODES.....	31
1.12.1	Power ON.....	31
1.12.2	Power OFF .....	31
1.12.3	Power up from Standby Mode .....	32
1.13	NAVIGATION .....	32
1.13.1	Set Date, Time and Language.....	32
1.13.2	Themes .....	33
1.13.3	DRUCK DPI612 Manual.....	33
1.14	SOFTWARE AND FIRMWARE UPGRADES.....	33
1.14.1	Viewing Software Revision.....	33
1.14.2	Upgrading the Software.....	33
1.14.3	Upgrade the Application Software.....	34
1.14.4	Upgrade the Operating System and Boot Loader Software. ....	34
1.15	MAINTENANCE.....	35
1.15.1	Cleaning .....	35
1.15.2	Replace the Batteries.....	35

1.16	INSTRUMENT RETURN.....	35
1.16.1	Returned Material Procedure.....	35
1.16.2	Safety Precautions.....	35
1.16.3	Important Notice.....	36
1.16.4	Instrument Disposal in the European Union.....	36
1.16.5	For more information contact.....	36
1.17	ENVIRONMENT.....	36
1.18	MARKS AND SYMBOLS ON THE EQUIPMENT.....	37
2	OPERATIONS.....	38
2.1	COMMON OPERATIONS.....	38
2.1.1	Attach/Remove the device under test.....	38
2.1.2	Attach a Pressure Relief Valve.....	40
2.1.3	Setting a Pressure Relief Valve.....	41
2.2	DPI 612 PFLEX & PFLEXPRO PNEUMATIC PRESSURE OPERATIONS.....	42
2.2.1	Introduction.....	42
2.2.2	Release the Pressure.....	42
2.2.3	Vacuum or Pressure Operation DPI 612 pFlex (20 bar).....	43
2.2.1	Release Pressure DPI 612 pFlex (20 bar).....	43
2.2.2	Vacuum or Pressure Operation DPI 612 pFlexPro (100 bar).....	44
2.2.3	Release pressure DPI 612 pFlexPro (100 bar pump).....	46
2.3	DPI 612 HFLEXPRO (1000 BAR) HYDRAULIC OPERATIONS.....	46
2.3.1	First Use.....	47
2.3.2	Filling and Priming the Pump.....	47
2.3.3	Topping up the Hydraulic Fluid.....	48
2.3.4	Priming Sequence.....	49
2.3.5	Applying Hydraulic Pressure (1000 bar).....	50
2.3.6	Release Hydraulic Pressure (1000 bar pump).....	51
2.3.7	Drain Excess Hydraulic Fluid.....	51
2.3.8	Drain all the Hydraulic Fluid.....	52

User Manual	
2.4	CALIBRATOR OPERATIONS ..... 54
2.4.1	Basic Calibrator Operation..... 54
2.4.2	Set the Function Utility Options ..... 60
2.4.3	Measurement Display Options..... 63
2.4.4	Example Procedures ..... 64
2.5	PRESSURE CALIBRATION..... 69
2.5.1	Set up a Leak Test ..... 70
2.5.2	Set the Pressure Module to Zero ..... 72
2.5.3	Error Indications..... 72
2.6	MEASURE PRESSURE: IDOS OPTION ..... 72
2.6.1	IDOS Option Assembly Instructions..... 73
2.6.2	IDOS Function Procedures ..... 73
3	DATA LOGGING OPERATION..... 75
3.1	SET-UP ..... 76
3.2	OPERATION..... 77
3.3	FILE REVIEW ..... 78
3.4	FILE MANAGEMENT ..... 78
3.4.1	Transfer ..... 78
3.4.2	Erase ..... 79
3.4.3	Memory Status..... 79
3.5	DATA FORMAT ..... 79
4	DOCUMENTATION ..... 81
4.1	ANALYSIS..... 81
4.2	SET-UP..... 82
4.2.1	Define the Reference Channel ..... 82
4.2.2	Define each Input Channel ..... 82
4.3	ANALYSIS FUNCTION ..... 84
4.4	RUN PROCEDURE ..... 84
4.4.1	Sequence to Upload and Download file..... 85

5	CALIBRATION.....	86
5.1	GENERAL.....	86
5.2	CALIBRATION CHECK.....	86
5.3	CALIBRATION ADJUSTMENTS.....	87
5.4	BEFORE STARTING.....	87
5.5	PROCEDURES: CURRENT (MEASURE).....	88
5.6	PROCEDURES: CURRENT (SOURCE).....	89
5.7	PROCEDURES: DC MV/VOLTS (MEASURE).....	90
5.8	PROCEDURES: DC VOLTS (SOURCE).....	91
5.9	PROCEDURES: PRESSURE INDICATOR.....	92
5.10	PROCEDURES: IDOS UPM.....	93
6	ACCESSORY INSTRUCTIONS.....	94
6.1	DIRT MOISTURE TRAP 20 BAR (P/N IO620-IDT621).....	94
6.1.1	Specification:.....	94
6.1.2	Pressure connections:.....	94
6.1.3	Operation:.....	94
6.1.4	Cleaning:.....	95
6.2	DIRT MOISTURE TRAP 100 BAR (P/N IO620-IDT622).....	96
6.2.1	Specification:.....	96
6.2.2	Pressure connections:.....	96
6.2.3	Operation:.....	96
6.2.4	Cleaning:.....	97
7	GENERAL SPECIFICATION.....	98
8	TROUBLESHOOTING.....	101
8.1	DPI 612 PFLEX.....	101
8.2	DPI 612 PFLEXPRO.....	102
8.3	DPI 612 HFLEXPRO.....	103
8.4	GENERAL.....	104
9	MANUFACTURER.....	105

# 1 INTRODUCTION

The Druck DPI612 is a battery-powered instrument for performing pressure and electrical calibration operations. The Druck DPI612 also supplies the power and user interface functions for all optional items. The DPI612 uses the PM620 pressure module to allow user selection of the most suitable pressure range for the task.

## 1.1 EQUIPMENT IN THE BOX

The following are the common items supplied with the Druck DPI612

- 1/8" NPT & BSP pressure adaptors
- Set of four test leads
- Safety and Quick Start Guide
- Stylus
- Hand & Shoulder straps

Refer to DPI612 datasheet for full list of accessories supplied with each DPI612 model.

## 1.2 OBSERVANCE OF THE USER MANUAL

This manual contains safety and battery installation information for the Druck DPI612. It is the responsibility of the customer to make sure that all personnel operating and maintaining the equipment are correctly trained and qualified. Before using the equipment, read all sections of this User Manual paying particular attention to all WARNINGS and CAUTIONS given in the Quick Start Guide.

## 1.3 GENERAL SAFETY PRECAUTIONS

Read and obey all the operator's local health and safety regulations and safe working procedures or practices when doing a procedure or task.

- Use only the approved tools, consumable materials and spares to operate and maintain the equipment.
- Use equipment only for the purpose for which it is provided.



- Wear all applicable Personal Protective Equipment (PPE).
- Do not use sharp objects on the touch-screen.
- Observe absolute cleanliness when using the instrument.
- Severe damage can be caused if equipment connected to this instrument is contaminated.
- Connect only clean equipment to the instrument. To avoid any contamination, an external Dirt Moisture Trap (See Section 1.10.7) is recommended
- Some liquid and gas mixtures are dangerous. This includes mixtures that occur because of contamination. Make sure that the equipment is safe to use with the necessary media.
- Read and obey all applicable **WARNING** and **CAUTIONS** signs.
- Make sure that:
  - All work areas are clean and clear of unwanted tools, equipment and materials.
  - All unwanted consumable materials are disposed in accordance with local health and safety and environmental regulations.
  - All equipment is serviceable.

## 1.4 WARNINGS



- Do not ignore the specified limits for the instrument or its related accessories. This can cause injuries.
- If the equipment is used in a manner not specified by the manufacturer, the protection provided by the equipment may be impaired.
- Do not use the instrument in locations with explosive gas, vapour or dust. There is a risk of an explosion.

## 1.5 ELECTRICAL SAFETY



- The DC input to the DPI612 is rated at 5V (+/-5%) 4 Amps.
- External circuits should have appropriate insulation to the mains.
- To prevent electrical shocks or damage to the instrument, do not connect more than 30V CAT I between the terminals or between the terminals and the ground (earth).
- This instrument uses a rechargeable battery pack or standard AA size batteries. To prevent an explosion or fire do not short circuit.
- The power supply input range to the optional power supply unit is 100 – 260Vac, 50 to 60Hz, 250mA, installation category CAT II.
- When using the optional power supply unit, position the power supply so as not to obstruct the supply disconnecting device.
- Note that the operating and storage temperature range of the optional PSU does not match that of the DPI612. Mains PSU operating temperature range 0°C to +40°C, storage temperature range -40°C to +70°C.
- To make sure the display shows the correct data, disconnect the test leads before power is set to **ON** or changing to another measure or source function.
- Keep the leads free from all contaminants.

## 1.6 RECHARGABLE BATTERY WARNINGS



- Do not disassemble or modify the battery pack. The battery pack can leak electrolyte, overheat, emit smoke, burst and/or ignite.
- Do not short-circuit the battery.
- Do not transport or store the battery pack together with metal objects. If short-circuiting occurs, over-current will flow, causing the battery pack to leak electrolyte, overheat, emit smoke, burst and/or ignite.
- Do not discard the battery pack into fire or heat it.
- Do not expose cells or batteries to heat or fire. Avoid storage in direct sunlight.
- Do not use or leave the battery pack near a heat source (+80°C or higher).
- Do not immerse the battery pack in water. Do not allow it to get wet.
- Do not recharge the battery pack near fire or in extremely hot weather.
- To recharge the battery use the DPI611 and DPI612 internal charging function or the CX6100GE desktop charger. Do not use any other charger.
- Do not subject the battery pack to mechanical shock.
- Do not use an apparently damaged or deformed battery pack.
- Do not directly solder the battery pack.
- Do not reverse the positive (+) and negative (-) terminals.

Otherwise, during recharging, the battery pack will be reverse-charged, abnormal chemical reactions then may occur, or excessively high current can flow during discharging, leading to electrolyte leakage, overheating, smoke emission, bursting and/or ignition.

- Do not force the connection if you cannot easily connect the battery pack terminals to the battery pack charger. Confirm that the terminals are correctly oriented.
- Do not use the battery pack for a purpose other than powering either DPI611/DPI612 products.
- Do not use any battery which is not designed for use with the equipment.
- Do not connect the battery pack to any other electrical outlet.
- Do not mix batteries of different manufacture, capacity, size or type within the DPI611 or DPI612.
- If recharging operation fails to complete even when a specified recharging time has elapsed, immediately stop further recharging.
- Do not put the battery pack into a microwave oven. Rapid heating or disrupted sealing can lead to electrolyte leakage, overheating, smoke emission, bursting and/or ignition.
- If electrolyte leaks from the battery pack or gives off a bad odour, remove it from any exposed flame. Otherwise, the leaking electrolyte may catch fire and the battery pack may emit smoke, burst or ignite.
- If the battery pack gives off an odour, generates heat, becomes discoloured or deformed, or in any way appears abnormal during use, recharging or storage, immediately remove it from the equipment or battery pack charger and stop using it. Otherwise, the problematic battery pack can develop electrolyte leakage, overheating, smoke emission, bursting and/or ignition.

- Remove the battery from the equipment when not in use.



- Do not remove the battery from its original packaging until required for use.
- Secondary batteries need to be charged before use. Always use the correct charger and refer to the user manual for proper charging instructions.
- Do not leave a battery on prolonged charge when not in use.
- After extended periods of storage, it may be necessary to charge and discharge the battery several times to obtain maximum performance.
- Do not subject the battery pack to intense sunlight or hot temperatures, for example in a car during hot weather. Otherwise, electrolyte leakage, overheating and/or smoke emission can occur. Also, its guaranteed performance will be lost and/or its service life will be shortened.
- The battery pack incorporates built-in safety devices. Do not use it in a location where static electricity is present.
- The guaranteed recharging temperature range is 0°C to +45°C. A recharging operation outside this temperature range can lead to electrolyte leakage and/or overheating of the battery pack and may cause damage to it.
- In the event of a cell leaking, do not allow the liquid to come in contact with the skin or eyes. If contact has been made, wash the affected area with copious amounts of water and seek medical advice.
- Seek medical advice immediately if material or content from a battery has been swallowed
- Keep the battery out of the reach of children.
- Keep batteries clean and dry.

- Wipe the battery terminals with a clean dry cloth if they become dirty.
- If you find rust, a bad odour, overheating and/or other irregularities when using the battery pack for the first time, return it to your supplier or vendor.
- For further information contact the nearest distributor or representative.
- Retain the original product literature for future reference.

## 1.7 PRESSURE WARNINGS



- It is dangerous to attach an external source of pressure to a DPI612 pressure station. Use only the internal mechanisms to set and control pressure in the pressure station.
- To prevent a dangerous release of pressure, isolate and bleed the system before disconnecting a pressure connection.
- To prevent a dangerous release of pressure, make sure that all the related pipes, hoses and equipment have the correct pressure rating, are safe to use and are correctly attached.
- To prevent damage to the DPI612 calibrator, only use it within the specified pressure limits.
- Do not exceed the maximum pressures stated in the appropriate component manual for the unit under test.
- Reduce pressure at a controlled rate when venting to atmosphere.
- Carefully de-pressurize all pipes to atmospheric pressure before disconnecting and connecting to the unit under test.
- Always wear appropriate eye protection when working with pressure.

## 1.8 OVERVOLTAGE CATEGORY

The following summary of installation and measurement overvoltage categories are derived from IEC61010-1. The overvoltage categories indicate the severity of overvoltage transients.

**Table 1-1**

Overvoltage Category	Description
CAT I	<i>Overvoltage category I has the least severe overvoltage transients. Generally CAT I equipment is not designed to be directly connected to the mains supply. Examples of CAT I equipment are process loop powered devices.</i>
CAT II	<i>Overvoltage category II describes an electrical installation where typically single phase equipment is connected. Examples of such equipment are appliances and portable tools.</i>

## 1.9 PREPARING THE INSTRUMENT

On receipt of the instrument check the contents in the box, listed in accessories See Section 1.10. It is recommended to retain the box and packaging for future use.

### 1.9.1 Initial Checks

Before you use the instrument for the first time:

- Make sure that there is no damage to the instrument, and that there are no missing items; See Section 1.10.
- Remove the plastic film that protects the display.

### 1.9.2 Install Rechargeable Battery and Cradle

For a new unit steps 1-4 will have been completed in the factory prior to delivery.

1. Remove the battery cover by loosening the captive battery cover fixing screw and lifting the cover upwards.
2. If fitted, remove white battery holder by pulling straight up to reveal charging cable. Remove foam block from battery cover.

3. Connect the charging cable to the rechargeable battery cradle.
4. Push the cradle firmly into the battery compartment.
5. Insert the rechargeable battery into the cradle.
6. Replace the battery cover by pressing the lugs inside the slots (A) and bring down the cover, securing by tightening the fixing screw. (See Figure 1-1).
7. The battery can be charged by connecting the wall adapter to the unit or by using the optional desktop charger.

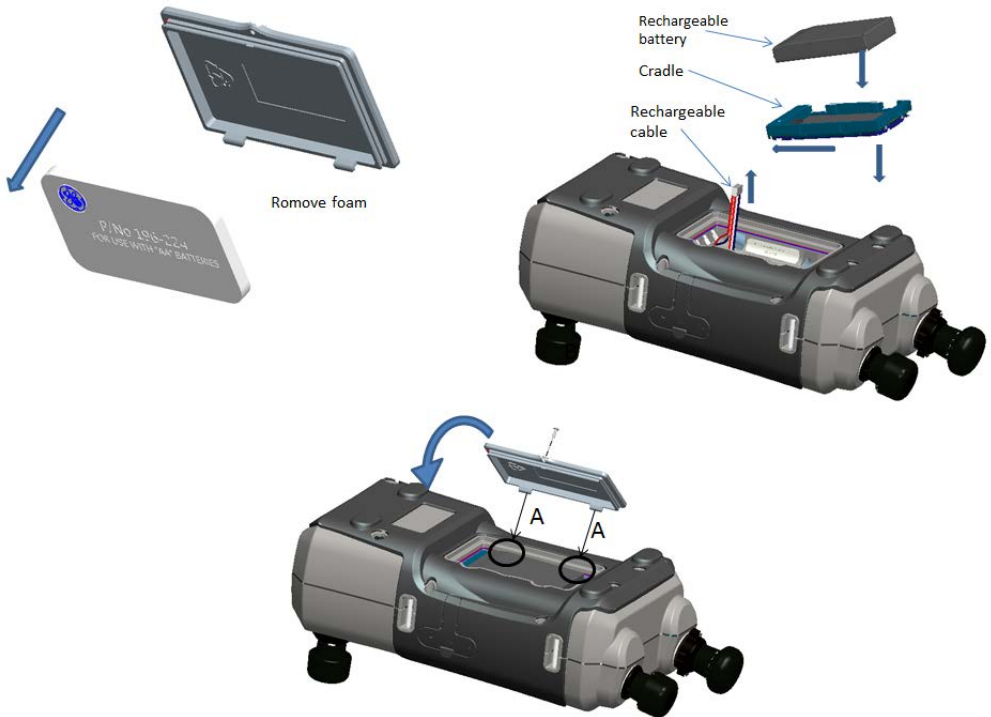

Figure 1-1 Fit Rechargeable Pack



### 1.9.3 Install Dry Cell Batteries

1. Remove the battery cover by loosening the captive battery cover fixing screw and lifting the cover upwards.
2. If the rechargeable battery has been fitted, remove it.
3. If the rechargeable battery cradle has been fitted, remove it by gently pulling it straight up. Avoid touching the metal contacts on the cradle. Note the cradle is attached to the unit with the charging cable.
4. Disconnect the charging cable from the back of the cradle and keep it loose in the small compartment then fit battery holder.
5. Fit the foam block to the battery cover.
6. Place the batteries in the battery compartment with the correct +/- position.



#### **Incorrect Insertion of batteries can cause battery failure.**

7. Replace the battery cover by pressing the lugs inside the slots (A) and bring down the cover, securing by tightening the fixing screw. (See *Figure 1-2*).

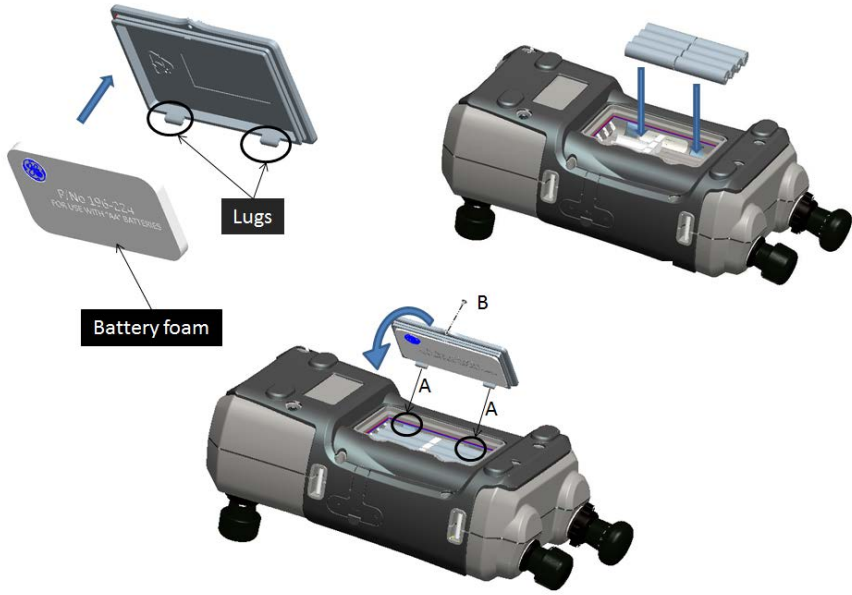

Figure 1-2 Fit Dry Cell Batteries

1.10.1 DPI 612

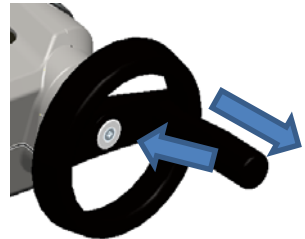
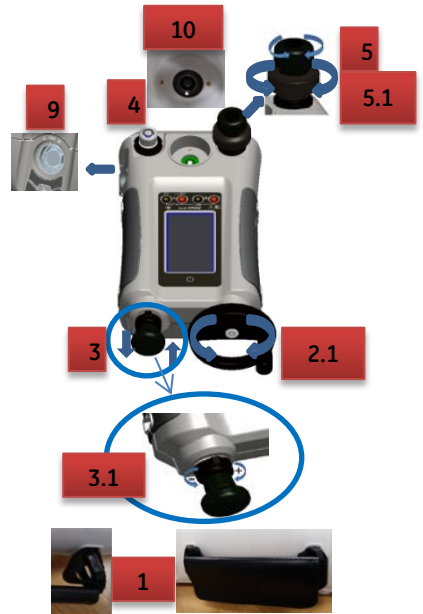



Figure 1-3 DPI612 Pressure Calibrator

Table 1-2

Item No.	Description
1	ON or OFF button.
2	PFX only: Pneumatic volume adjuster.
2.1	PFP, HFP models only: Volume adjuster wheel with fold-in handle.
3	Pump mechanism.
3.1	PFX, PFP models only: Pressure/vacuum selector to set the pump operation: pressure (+), vacuum (-).
4	Test port: To attach the device under test.
5	Pneumatic pressure release valve to release pressure in the system.

			Item No.	Description
			5.1	PFP models only: Pneumatic refill valve. Close it to seal off the device pressure and refill the pressure mechanism.
			6	CH1 connectors for: Voltage (V); Current (mA+, mA-); Switch operation.
			7	Isolated CH2 connectors for: Voltage (V); 24 V loop power supply (24 Vo).
			8	Liquid Crystal Display (LCD): Color display with touch-screen. To make a selection, lightly tap on the applicable display area.
			9	Optional accessory (not shown): Pressure connection for a relief valve (PRV). A blanking plug is standard.
			10	Pressure and electrical connections for a PM620 module (not shown): DPI612 models PFX and PFP: Seal the pressure connection with a blanking plug (Part: IO620-BLANK) or a PM 620 module. DPI612 HFP models only: The pressure connection seals itself.
			11	HFP models only: Hydraulic refill valve (not shown): Close it to seal off the device pressure and refill the pressure mechanism with fluid.
			12	Hand straps
			13	+5 V DC power input socket. This supply also charges the optional battery pack.
			14	USB type A connector for connections to external peripherals (USB flash memory or optional external modules).
			15	USB mini-type B connector for communication with a computer.

### 1.10.2 Test Port

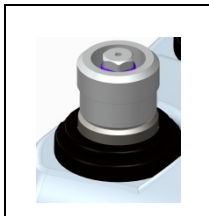

**Figure 1-4**  
**Test port**

To attach the device under test, the test port uses “Quick fit” pressure adaptors; *See Section 1.10.10*. These are easy to remove, change and install; *See Section 2.1.1* (Attach/Remove the device under test).

### 1.10.3 Pressure Release Valve



**Figure 1-5**  
Pressure  
Release Valve

This is a needle point valve that lets you release the pressure or vacuum, or seal the system.



OPEN



CLOSE

### 1.10.4 SELECTOR DPI 612 pFlex & pFlexPro (20 & 100 bar)



**Before you turn the pressure/vacuum selector to + or -, release all the pressure. Sudden high pressure in the pump mechanism can cause damage.**



**Figure 1-6**  
Selector

This control sets the operation of the instrument (pressure or vacuum). To prevent a pressure leak, turn it fully clockwise or counter clockwise.

+ : Pressure, - : Vacuum

### 1.10.5 Pump

#### *DPI 612 pFlex (20 bar) Pump*

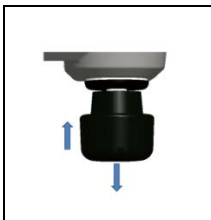
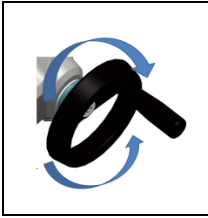

**Figure 1-7**  
20 bar Pump

When you have set the operation to pressure or vacuum (See Section 1.9.4), seal the system (See Section 1.9.3) and use the pump to set the necessary pressure or vacuum.

You can then make the last adjustments with the volume adjuster (See Section 1.9.6).

### DPI 612 pFlexPro (100 bar) Pump

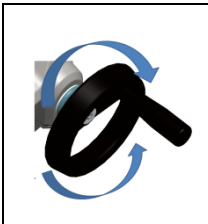

**Figure 1-8**  
**100 bar Pump**

When you have set the operation to pressure or vacuum (See *Section 1.9.4*), seal the system (See *Section 1.9.3*) and use the pump to set the necessary pressure or vacuum.

You can then make the last adjustments with the volume adjuster (See *Section 1.9.6*).

### DPI 612 hFlexPro (1000 bar) Pump



**Figure 1-9**  
**1000 bar Pump**

When you have set the operation to pressure or vacuum (See *Section 1.9.4*), seal the system (See *Section 1.9.3*) and use the pump to set the necessary pressure or vacuum.

You can then make the last adjustments with the volume adjuster (See *Section 1.9.6*).

## 1.10.6 Volume Adjuster

### DPI 612 pFlex (20 bar) Volume Adjuster

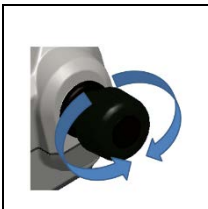

**Figure 1-10**  
**20 bar Volume Adjuster**

This control increases or decreases the pressure/vacuum.

Before you seal the system (See *Section 1.9.3*), turn this control to the necessary position:

- For equal adjustment, turn it to the middle of its range.
- For maximum adjustment, turn it fully clockwise or counter clockwise.

When you have set the necessary pressure or vacuum with the pump (See *Section 1.9.5*), use the volume adjuster to make the fine adjustments.

### DPI 612 pFlexPro (100 bar) Volume Adjuster

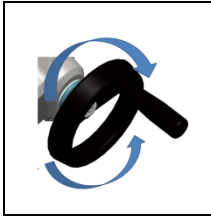

**Figure 1-11**  
**100 bar**  
**Volume**  
**Adjuster**

This control increases or decreases the pressure/vacuum.

Before you seal the system (*See Section 1.9.3*), turn this control to the necessary position:

- For equal adjustment, turn it to the middle of its range.
- For maximum adjustment, turn it fully clockwise or counter clockwise.

When you have set the necessary pressure or vacuum with the pump (*See Section 1.9.5*), use the volume adjuster to make the fine adjustments.

### DPI 612 hFlexPro (1000 bar) Volume Adjuster



**Figure 1-12**  
**1000 bar**  
**Volume**  
**Adjuster**

This control increases or decreases the pressure/vacuum.

Before you seal the system (*See Section 1.9.3*), turn this control to the necessary position:

- For equal adjustment, turn it to the middle of its range.
- For maximum adjustment, turn it fully clockwise or counter clockwise.

When you have set the necessary pressure or vacuum with the pump (*See Section 1.9.5*), use the volume adjuster to make the fine adjustments.



### 1.10.7 Refill Valve

#### *DPI 612 pFlexPro (100 bar) Refill Valve*

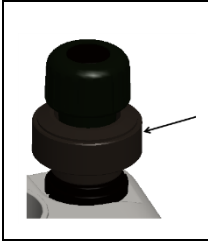

**Figure 1-13**  
**100 bar Refill**  
**Valve**

When pressurising large volumes this can be used to refill the pump without releasing pressure from the UUT (see Section 2.2.2)

#### *DPI612 hFlexPro (1000 bar) Refill Valve*

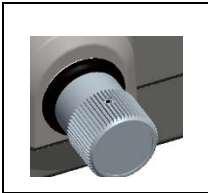

**Figure 1-14**  
**1000 bar**  
**Refill Valve**

When pressurising large volumes this can be used to refill the pump without releasing pressure from the UUT (see Section 2.3.4)

### 1.10.8 Priming Pump DPI612 hFlexPro (1000 bar)



**Figure 1-15**  
**1000 bar**  
**Priming**  
**Pump**

This control is used to fill and generate a priming pressure on the UUT (approx. 10 bar max)  
(see Section 2.3.4)

## 1.11 ACCESSORIES:

### 1.11.1 Carry Case (P/N IO612-CASE-3)

A tailored fabric carry case with carrying strap allows the DPI612 to be used without removing it from the case.

### 1.11.2 Rechargeable Battery pack (P/N CC3800GE)



Use in place of AA cells. The battery pack is charged within the instrument.

### 1.11.3 Rechargeable Battery and adaptor kit (P/N IO61X-BAT-KIT)

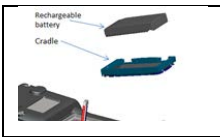

Kit contains 3.7V Li-ion battery, Cradle, Battery Cover and power adapter.

### 1.11.4 Rechargeable Desktop Charger (P/N CX6100GE)



To Charge the Li-ion battery outside of the unit.

### 1.11.5 Mains Adaptor (P/N IO620-PSU)



A universal input mains adaptor (Input voltage 100 to 240VAC (50/60Hz) and Mains socket adaptors are provided.

### 1.11.6 USB Cable (P/N IO620-USB-PC)

It connects the DPI612 to a PC via a USB port.

### 1.11.7 IDOS to USB Converter (P/N IO620-IDOS-USB)



It allows connection of an IDOS universal pressure module to the DPI612. USB Cable (P/N IO620-USB-PC) is also required to connect the converter to the DPI612 USB port.

### 1.11.8 USB to RS 232 Cable (P/N IO620-USB-RS232)

It connects the DPI612 to an RS232 interface.

### 1.11.9 Dirt Moisture Trap 20 bar (P/N IO620-IDT621)



It prevents contamination of the DPI612 PFLEX pneumatic system and cross contamination from one device under test to another. The trap connects directly to the pressure port and replicates the quick fit connection for compatibility with standard adaptors, adaptor kits and hoses. User instructions are in section 6.1

### 1.11.10 Dirt Moisture Trap 100 bar (P/N IO620-IDT622)



It prevents contamination of the DPI612 PFlexPro pneumatic system and cross contamination from one device under test to another. The trap connects directly to the pressure port and replicates the quick fit connection for compatibility with standard adaptors, adaptor kits and hoses. User instructions are in section 6.2

### 1.11.11 Pneumatic Hose (PN IO620-HOSE-P1 / IO620-HOSE-P2)



A high pressure pneumatic hose rated to 400 bar (5800 psi). The hose connects directly to the DPI612 pressure port and replicates the quick fit connection for compatibility with the standard adaptors supplied and the other adaptor kits.

P/N IO620-HOSE-P1: 1m/3,2ft pneumatic adaptor hose

P/N IO620-HOSE-P2: 2m/6.4ft pneumatic adaptor hose

### 1.11.12 Hydraulic Hose (PN IO620-HOSE-H1 / IO620-HOSE-H2)



A high pressure Hydraulic hose rated to 1000 bar (15000 psi). The hose connects directly to the DPI612 pressure port and replicates the quick fit connection for compatibility with the standard adaptors supplied and the other adaptor kits.

P/N IO620-HOSE-H1: 1m/3,2ft pneumatic adaptor hose

P/N IO620-HOSE-H2: 2m/6.4ft pneumatic adaptor hose

### 1.11.13 Low Pressure Pneumatic Hose (PN IOHOSE-NP1 / IOHOSE-NP2)

A low pressure pneumatic hose rated to 20 bar (300 psi). The hose connects directly to the DPI612 pressure port and replicates the quick fit connection for compatibility with the standard adaptors supplied and the other adaptor kits.

P/N IOHOSE-NP1: 1m/3,2ft pneumatic adaptor hose

P/N IOHOSE-NP2: 2m/6.4ft pneumatic adaptor hose

### 1.11.14 Pressure Adaptor set



A set of test point adaptors to connect the tool-less quick fit DPI612 pressure port or the extension hoses to the device under test.

P/N IO620-BSP: G1/8 male and G1/4 male, G1/4 female, G3/8 female and G1/2 female.

P/N IO620-NPT: 1/8" male and 1/4" male, 1/4" female, 3/8" female and 1/2" female.

P/N IO620-MET: 14mm female and 20mm female.

### 1.11.15 Comparator Adaptor (P/N IO620-COMP)



For greater efficiency, two test devices can be connected at the same time. The adaptor connects to the pressure port of the DPI612 and provides two outlet ports. It is compatible with the standard adaptors supplied and the adaptor kits.

### 1.11.16 Pressure Module (P/N IPM620-\*\*\*)



Select the best pressure range for the job from an extensive list of high accuracy pressure ranges. Ranges available from 25mbar upto 1000 bar (10 ln H<sub>2</sub>O upto 15000 psi)

### 1.11.17 Pressure Relief Valve (PRV)

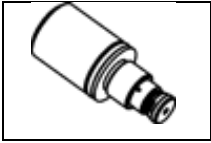

To give your attached devices overpressure protection (device under test, PM 620 module), we recommend you use one of our range of optional PRVs;

Available for pneumatic and hydraulic versions

## 1.12 DRUCK DPI612, MODES

### 1.12.1 Power ON

From **OFF** – momentarily press the power button until the GE Logo appears.

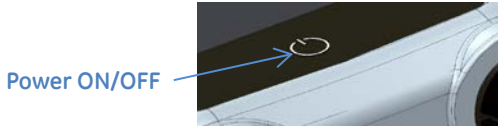
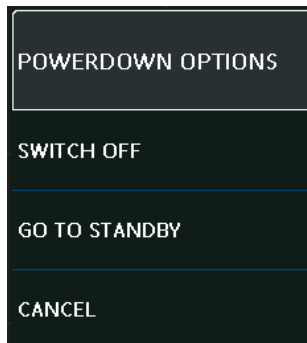

**Figure 1-16 Power Button**

### 1.12.2 Power OFF

Press and Release the Power Button:

Select SWITCH OFF from the POWERDOWN OPTIONS window displayed.



**Figure 1-17 Power Down Options**

**SWITCH OFF** – Full power down of DPI612 – Recommended if unit is not going to be used for several hours (Requires full reboot on next power up).

**GO TO STANDBY**– DPI612 placed in standby mode – Reduced power consumption from operating mode – recommended if unit is to be inactive for short periods. (DPI612 has fast turn on from STANDBY mode).

**CANCEL** – Touch CANCEL option if you do not want to Switch Off or Standby the instrument.

### 1.12.3 Power up from Standby Mode

When powered-up from standby mode the instrument always opens the last screen shown before going into standby mode.

## 1.13 NAVIGATION

On power up the DPI612 displays the Dashboard. The user should select the desired option by touching the appropriate icon. Function screens are navigated by swiping a finger from right to left while touching the screen. List menus are navigated by swiping a finger up and down while touching the screen.

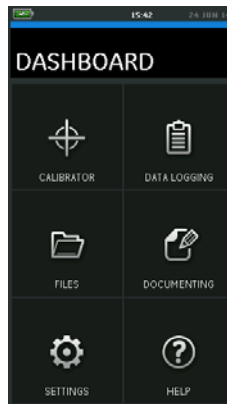

Figure 1-18 Dash Board

### 1.13.1 Set Date, Time and Language

To access Date, Time and Language menus

Select:

DASHBOARD >>  SETTINGS >> DATE

**Note:** The DPI612 will maintain the date and time for 30 days after being left without batteries. In case of loss of date and time, replace the batteries, connect the mains adaptor to the DPI612 and keep it turned on for 50 hours to fully recharge the clock battery.



### 1.13.2 Themes

Two themes are available: Dark and Light; select the correct theme for the light level.

Select:

DASHBOARD >>  SETTINGS >> THEME

### 1.13.3 DRUCK DPI612 Manual

Select the Help icon on the Dashboard to access the manual. The manual can be downloaded onto a memory stick for viewing or printing on a remote PC.

DASHBOARD >>  HELP

## 1.14 SOFTWARE AND FIRMWARE UPGRADES

### 1.14.1 Viewing Software Revision

The software revisions running on the DPI612 can be viewed by selecting:

DASHBOARD >>  SETTINGS >> STATUS  
>> SOFTWARE BUILD

**Note:** If the software revision number is highlighted red then an upgrade is available.

### 1.14.2 Upgrading the Software

Follow the website instructions to download the files onto a USB flash memory drive.

[www.gemeasurement.com](http://www.gemeasurement.com)

DASHBOARD >>  SETTINGS  
>> ADVANCED

Enter the calibration PIN: 5487; Select the ✓ button and continue upgrade with one of these operations.

### 1.14.3 Upgrade the Application Software

1. Copy the 'AMC' application folder into the root of a USB flash memory device.
2. Put the USB flash memory drive into the USB type A connector.
3. Select: APPLICATION
4. Follow the on-screen instructions.

### 1.14.4 Upgrade the Operating System and Boot Loader Software.

1. Copy the 'OS' folder into the root of a USB flash memory device.
2. Put the USB flash memory drive in the USB type A connector.
3. Select: OPERATING SYSTEM
4. Follow the on-screen instructions.

**Note:** The boot loader can only be upgraded as part of an operating system upgrade.

Notes:

- If a mistake is made during upgrade and there are no files to upload, follow the on-screen instructions and complete the procedure.
- When an upgrade completes normally, the initial operation of the touch screen may be slower (a period of approximately 30 seconds).
- To make sure the upgrade completed correctly, use the Status menu.

## 1.15 MAINTENANCE

The DPI612 instrument contains no user serviceable parts and should be returned to a GE service centre or an approved service agent for all repairs.

For more information, contact our customer service department at [www.gemeasurement.com](http://www.gemeasurement.com)

### 1.15.1 Cleaning



**Do not use solvents or abrasive materials.**

Clean the case and display with a lint-free cloth and a weak detergent solution.

### 1.15.2 Replace the Batteries

To replace the batteries, *See Section 1.8.2*. Then re-attach the cover. All the configuration options stay in memory.

## 1.16 INSTRUMENT RETURN

### 1.16.1 Returned Material Procedure

If the instrument is unserviceable and requires a repair return to a GE Service Center or approved Service Agents.

Web site: [www.gemeasurement.com](http://www.gemeasurement.com) Contact the GE Service Center, either by phone, fax or E-mail to obtain a Returned Material Authorization (RMA) number, providing the following information:

- Product (i.e. Druck DPI612)
- Serial number
- Details of defect/work to be undertaken
- Operating conditions

### 1.16.2 Safety Precautions

Provide information if the product has been in contact with any hazardous or toxic substances and, the relevant MSDS and or COSHH references and precautions to be taken when handling.

### 1.16.3 Important Notice

Do not use unauthorized sources to service this equipment as this will affect the warranty and may not guarantee further performance.

When discarding used equipment and batteries, obey all the local health and safety procedures.

### 1.16.4 Instrument Disposal in the European Union

Do not dispose this product or its battery as household waste.



Use an approved organization that collects and/or recycles the applicable item.

### 1.16.5 For more information contact

GE Sensing customer service department:





[www.gemeasurement.com](http://www.gemeasurement.com)

## 1.17 ENVIRONMENT

The following conditions apply for both shipping and storage:

- Temperature Range -20°C to +70°C (-40°F to +158°F)
- Altitude up to 15,000 feet (4,570 meters).

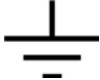
## 1.18 MARKS AND SYMBOLS ON THE EQUIPMENT

	Complies with European Union directives
	USB ports: Type A; Mini Type B connector
	Ground (Earth)
	DC adaptor polarity: the Centre of the plug is negative

## 2 OPERATIONS

### 2.1 Common Operations

#### 2.1.1 Attach/Remove the device under test



Pressurized gases are dangerous. Before you attach or disconnect pressure equipment, safely release all the pressure



To prevent damage to the instrument, do not let dirt get into the pressure mechanism. Before you attach equipment, make sure it is clean or use the applicable dirt trap.



**Figure 2-1**  
**Pressure Port**

The test port uses “Quick fit” pressure adaptors; See *Section 1.10* (Accessories). These are easy to remove, change and install (See 1.11.13).

a. Procedure (to Attach)

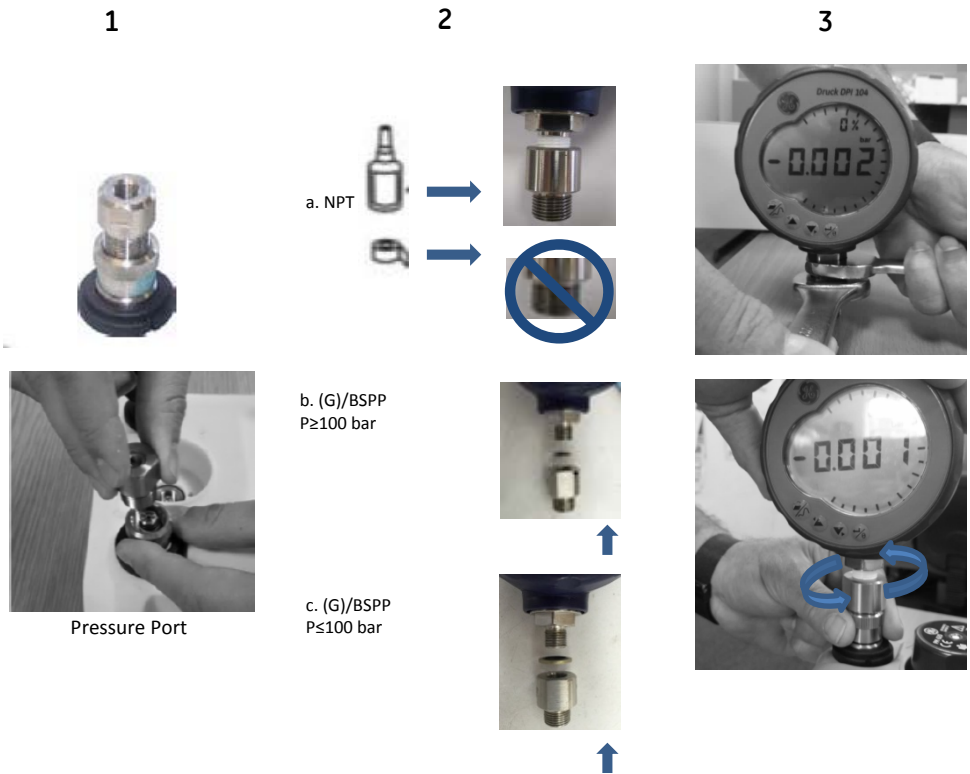

Figure 2-2 Attach / Remove Pressure connections

Table 2-1

Step	Procedure
1	Remove the adaptor
2	Use an applicable seal for the pressure connection: a. NPT type: Use an applicable sealant on the thread. b. BSP (parallel) type: We recommend a bonded seal at the bottom. c. BSP (parallel type, 100 bar (1500 psi) or less: a bonded seal at the top is permitted.
3	Attach the adaptor to the device; if necessary use one of the alternative adaptors listed in <i>Section 1.10</i> (Accessories), then tighten to the applicable torque.

Step	Procedure
4	Re-attach the adaptor to the test port and tighten it until it is hand tight only.

**b. Procedure (to Remove)**



To remove a device, first release the pressure (See Section 2.2.2). You can then do steps 4, 3, and 1 mentioned in Section 2.1.1. But do the operations in the reverse order.

**2.1.2 Attach a Pressure Relief Valve**

Optional accessory; see Section 1.10.13. Use a pressure relief valve (PRV) to set a limit to the pressure you can apply to the pressure devices attached to the pressure station. The PRV is set at the factory to operate at the maximum pressure specified on the label.

If the pressure in the instrument is more than the relief pressure set for the PRV, the PRV controls a slow release of the unwanted pressure. The correct PRV helps prevent overpressure and damage to the attached devices.

**Pneumatic**

	
<p style="text-align: center;">Step 1</p>	<p style="text-align: center;">Step 2</p>
<p>Choose a clean, dry PRV with the correct pressure value for the devices you are using and tighten it into position (hand tight only).</p>	<p>Choose a clean, dry PRV with the correct pressure value for the devices you are using and tighten it into position (hand tight only).</p>

**Note:** Before you put it into storage, make sure it is clean and dry.





In its normal condition, the DPI 612 hFlexPro contains hydraulic fluid. To make sure it does not spill out, seal the system and put it on its side before you install a PRV.

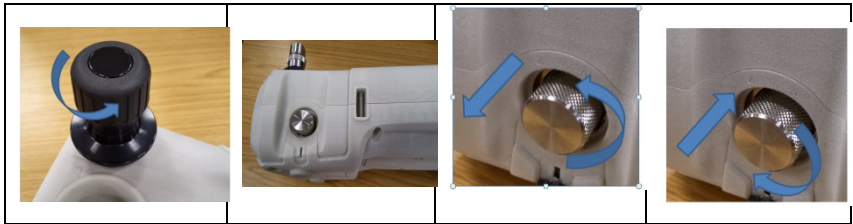

Step	Procedure
1	Seal the system.
2	Put the instrument on its side.
3	Remove the blanking plug or, if applicable, the PRV you are using. To collect possible drops of hydraulic fluid, put it in a container. <i>Note: Before you put it into storage, make sure it is clean and dry.</i>
4	Choose a clean, dry PRV with the correct pressure value for the devices you are using and tighten it into position (hand tight only).

### 2.1.3 Setting a Pressure Relief Valve

The PRV is set at the factory to operate at the maximum pressure specified on the label (on the plastic cap). For the adjustable range, refer to data sheet.

If necessary, use these steps to adjust the relief pressure:

Step	Procedure
1	Attach an applicable PM 620 module.
2	Remove the plastic cap from the end of the PRV
3	Set the necessary pressure with the pressure station

Step	Procedure
4	When the pressure in the pressure station is at the new PRV pressure, turn the adjustment screw until the PRV operates: <i>counter clockwise</i> decreases the operating pressure <i>clockwise</i> increases the operating pressure
5	Do steps 3 and 4 until the PRV operates at the correct pressure. Then press the plastic cap back into position.

## 2.2 DPI 612 pFlex & pFlexPro PNEUMATIC PRESSURE OPERATIONS

### 2.2.1 Introduction



**Figure 2-3**  
**DPI612**  
**Pressure**  
**Calibrator**

This section gives examples of how to connect and use the DPI612 pressure calibrator for the necessary pressure or vacuum operations.

Before you start:

- Read and understand the “Safety” section.
- Make sure that there is no damage to the instrument and there are no missing items.

**Note:** Use only original parts supplied by the manufacturer.

### 2.2.2 Release the Pressure



**Figure 2-4**  
**Pressure**  
**Release Valve**

To release all the pressure in this instrument, open the pressure release valve counter clockwise (1 turn).

To control a change in pressure conditions (for example, to go to or through another test pressure) use the volume adjuster (See Section 1.9.6) or open and close the pressure release valve.

2.2.3 Vacuum or Pressure Operation DPI 612 pFlex (20 bar)

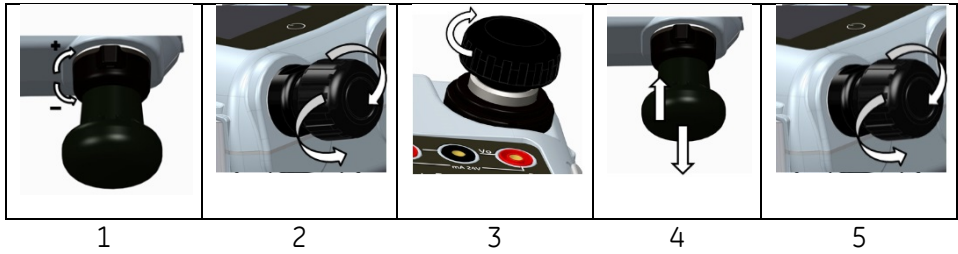

Figure 2-5 Vacuum or Pressure operation

Table 2-2

Step	Procedure (Vacuum)
1	Set to vacuum operation (-).
2	To do equal adjustments (up or down) at the end of the procedure, turn the volume adjuster to the middle of its range of operation.
3	Seal the system.
4	Use the pump to set the maximum vacuum or set the vacuum you want to adjust.
5	Adjust the vacuum (+ decrease; - increase).

Table 2-3

Step	Procedure (Pressure)
1	Set to Pressure operation (+).
2	To do equal adjustments (up or down) at the end of the procedure, turn the volume adjuster to the middle of its range of operation.
3	Seal the system.
4	Use the pump to set the maximum pressure or set the pressure you want to adjust.
5	Adjust the pressure (+ decrease; - increase).

2.2.1 Release Pressure DPI 612 pFlex (20 bar)



Open the pressure release valve counter clockwise (1 turn)

**Figure 2-6  
Pressure  
Release**

**2.2.2 Vacuum or Pressure Operation DPI 612 pFlexPro (100 bar)**

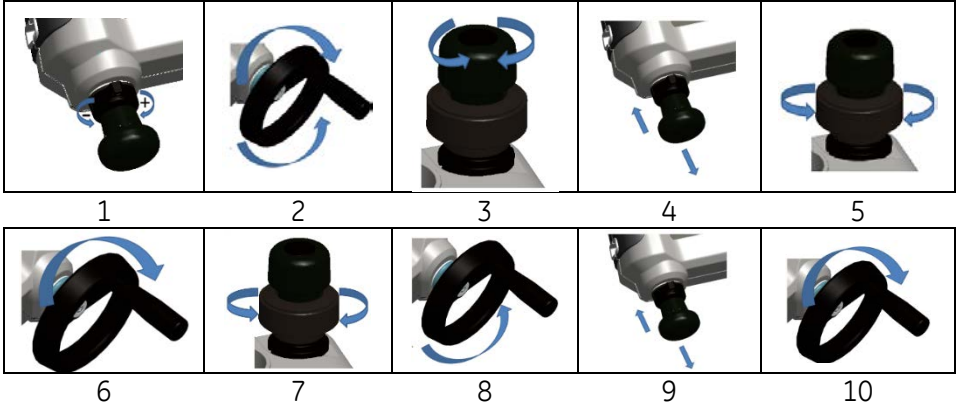

**Figure 2-7 Vacuum or Pressure operation**

**Table 2-4**

Step	Procedure (Vacuum)
1	Set to vacuum operation (-).
2	To do equal adjustments (up or down) at the end of the procedure, turn the volume adjuster to the middle of its range of operation.
3	Seal the system.
4	Use the pump to set the maximum vacuum or set the vacuum you want to adjust.
5	Adjust the vacuum (+ decrease; - increase).

**Table 2-5**

Step	Procedure (Pressure)
1	Set to Pressure operation (+).
2	To do equal adjustments (up or down) at the end of the procedure, turn the volume adjuster fully counter clockwise.
3	Seal the system.
4	Use the pump to pressurise the system (up to $\approx 20$ bar)
5	Open the refill valve (1 turn)
6	Increase the pressure with the volume adjuster
7	If increasing pressure the limit of travel is reached, close the refill valve
8	Wind the volume adjuster fully counter clockwise. There is no change in pressure.
9	Refill the pressure mechanism with the pump ( $\approx 15$ cycles)
10	Wind the volume adjuster clockwise until the pressure starts to increase
11	Continue to do steps 7 to 10 until you get the necessary pressure.

### 2.2.3 Release pressure DPI 612 pFlexPro (100 bar pump)

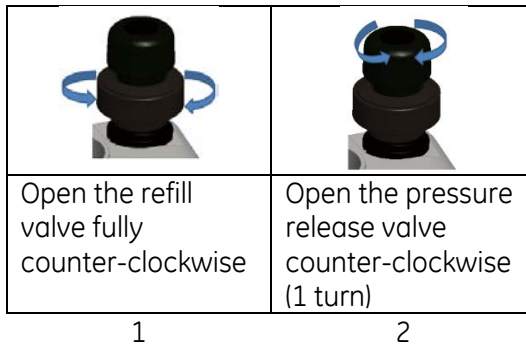

## 2.3 DPI 612 hFlexPro (1000 bar) HYDRAULIC OPERATIONS.



**WARNING**

**PRESSURIZED GASES AND FLUIDS ARE DANGEROUS. BEFORE CONNECTING OR DISCONNECTING PRESSURE EQUIPMENT, SAFELY RELEASE ALL THE PRESSURE.**

**ENSURE THAT THE SYSTEM IS BLED OF EXCESS AIR BEFORE OPERATION. (IF THE ITEM UNDER TEST HAS A LARGE VOLUME, PRE-FILL WITH THE PRESSURE FLUID TO ENSURE THAT TRAPPED AIR IS KEPT TO A MINIMUM).**



**CAUTION**

**To prevent damage to the pressure station, do not let dirt get into the pressure mechanism. Before connecting equipment, make sure it is clean.**

**Ice in the pressure mechanism can cause damage. If the temperature is less than 4°C (39°F), drain all water from the instrument.**

### 2.3.1 First Use

When using the DPI 612 hFlexPro pressure calibrator for the first time, fill the reservoir with the correct hydraulic fluid. Fill and prime the pressure station.

#### Fluid Type

Demineralised water or a mineral oil (Recommended ISO viscosity grade  $\leq 22$ ).

### 2.3.2 Filling and Priming the Pump

Ensure the sensor and test ports are clear before starting this procedure.

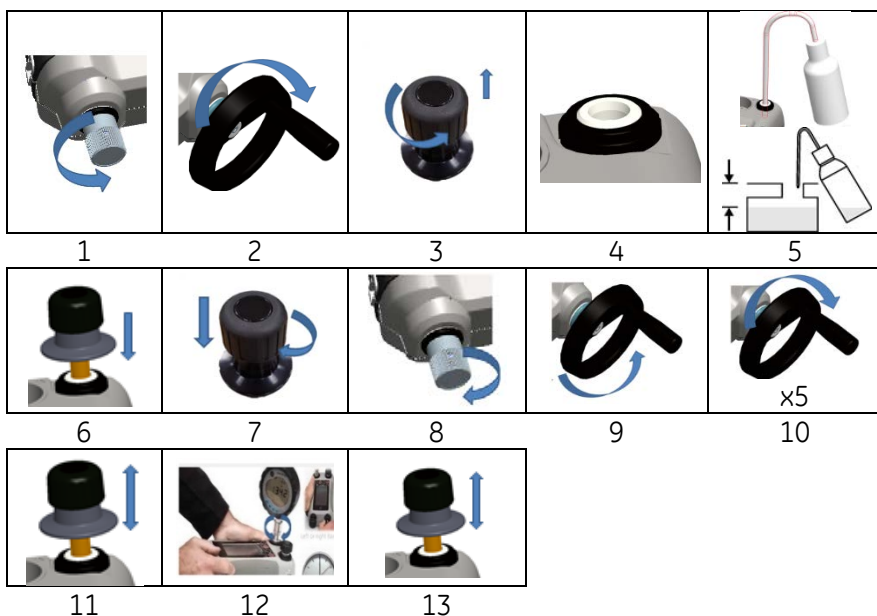

Step	Procedure
1	Turn the Refill valve fully counter-clockwise
2	Turn the Volume adjuster fully clockwise.
3	Turn the Release Valve Stem fully counter-clockwise.
4	Remove the Priming pump piston/Release valve stem assembly
5	Fill the reservoir with the recommended fluid, to $\approx 25$ mm from the top.

6	Re-fit the Priming pump piston/Release valve stem assembly
7	Turn the Release Valve Stem fully clockwise.
8	Turn the Refill valve fully clockwise, until finger tight.
9	Turn the Volume adjuster fully counter-clockwise.
10	Turn the Volume adjuster 5 turns clockwise.
11	Operate the Priming pump until the air is expelled and fluid is visible at the Test port.
12	Fit the "Item under test" to the Test port use the existing adaptor or the applicable AMC adaptor and applicable seals.
13	Operate the Priming pump and prime the system to a maximum pressure of 10 bar.

### 2.3.3 Topping up the Hydraulic Fluid

It will be necessary to top up the hydraulic fluid from time to time or if the device under test has a large fluid capacity. The DPI612 allows this to be done at any time.

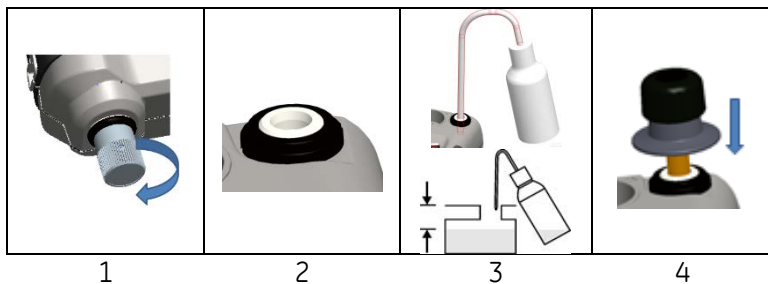

Step	Procedure
1	To seal off all the pressure in the test port and the pressure module connection, close the refill valve
2	Remove the hydraulic pressure release valve
3	Refill the reservoir with the same fluid, to $\approx 25\text{mm}$ from the top.
4	Seal the system and continue with the normal pressure procedure;



### 2.3.4 Priming Sequence

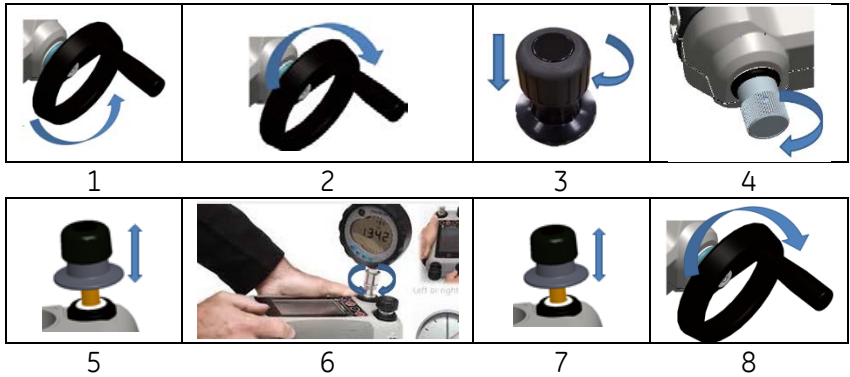

Step	Procedure
1	Turn the Volume Adjuster counter-clockwise. (See Section 1.9.7)
2	Turn the Volume Adjuster 10 turns clockwise
3	Close Release Valve.
4	Close Refill Valve clockwise, finger tight (See Section 1.9.8).
5	Operate Priming Pump until liquid is seen coming from the open test port / end of hose.
6	Connect IUT to open test port / end of hose.
7	Operate Priming Pump until pressure is indicated (max 10 bar)
8	Operate Volume Adjuster & Refill Valve to achieve required pressure. (See Section 2.3.5)

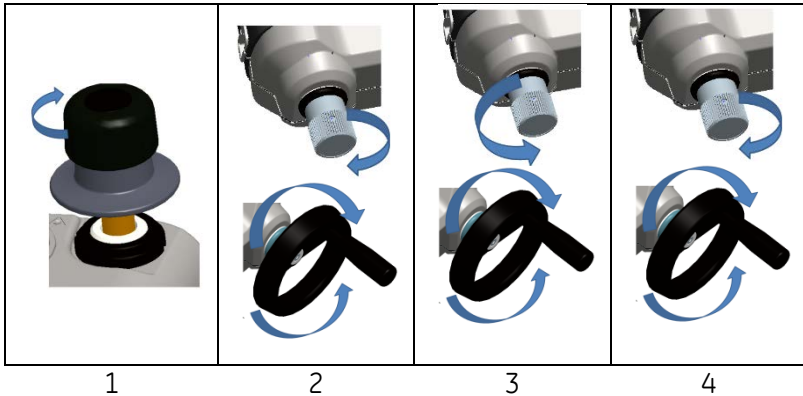

Note: If priming a long hose keep the open end of hose vertical to reduce trapping air.

### 2.3.5 Applying Hydraulic Pressure (1000 bar)



Step	Procedure
1	To seal the system
2	<p>Close the refill valve and then wind the volume adjuster fully clockwise and counter clockwise until the pressure starts to increase.</p> <p>Continue the clockwise/counter clockwise sequence until you get the necessary pressure OR for full control, go to step 3. The counter clockwise operation refills the pressure mechanism but there is no change in pressure to the device under test or the PM 620 module (if applicable).</p> <p><b>Note:</b> At higher pressures, it is easier to turn the wheel if you fold in the handle; see Section 1.4.5.</p>
3	For full control, open the refill valve (1 turn). You can now increase (+) or decrease (-) the pressure with the volume adjuster.
4	If you increase pressure and get to the limit of travel, close the refill valve again and wind the volume adjuster fully counter clockwise.
5	Continue to do steps 2 to 4 until you get the necessary pressure

### 2.3.6 Release Hydraulic Pressure (1000 bar pump)

	
1	2
Open the refill valve fully counter-clockwise	Open the pressure release valve counter-clockwise (1 turn)

### 2.3.7 Drain Excess Hydraulic Fluid

If you add more hydraulic fluid during the pressure procedure, drain this fluid out of the device when the pressure procedure is complete.

**Note:** *If it is safe and there is no risk of contamination, you can leave the hydraulic fluid inside the device.*

#### Preparation

To drain the device, we recommend these items:

- the applicable skin and eye protection
- a container that is large enough to hold the hydraulic fluid and prevent contamination of the work surface
- applicable materials to make sure the instrument and the area stay clean; see Chapter 6 (Maintenance procedures)

#### Procedure

- 1 Release the pressure (Section 2.3.6 Release Hydraulic pressure (1000 bar pump)).
- 2 Remove the device (Section 2.1.1) but do not let fluid spill onto the DPI 612 hFlexPro.
- 3 If necessary, drain the hydraulic fluid from the device under test.

**Note:** To discard the hydraulic fluid, obey all the local health and safety procedures.

### 2.3.8 Drain all the Hydraulic Fluid

In some conditions, it is necessary to fully drain the hydraulic fluid from your DPI 612 hFlexPro pressure calibrator; for example:

- if you are using water and the storage or operating temperature is going to be less than 4°C (39°F)
- if there is a long period of storage
- if there is unwanted material in the hydraulic fluid

#### *Preparation*

To drain the instrument, we recommend these items:

- the applicable skin and eye protection
- a container that is large enough to hold the hydraulic fluid and prevent contamination of the work surface
- applicable materials to make sure the instrument and the area stay clean;

**Procedure**

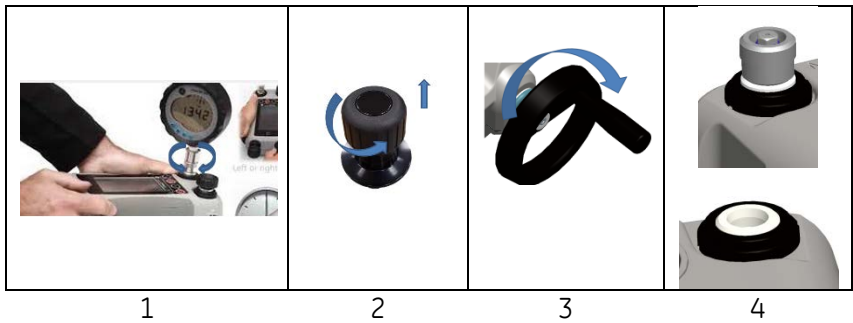

Step	Procedure
1	If applicable, release the pressure (Section 2.3.6) and remove the device (Section 2.1.1).
2	Remove the hydraulic pressure release valve.
3	Wind the volume adjuster wheel fully clockwise; this moves the fluid out of the pressure mechanism
4	<p>Put a container below the instrument then tilt the instrument up until <b>all</b> the fluid has come out. To discard the hydraulic fluid, obey all the local health and safety procedures.</p> <p><b>Note:</b> Fluid comes out of the test port and the connection for the pressure release valve.</p>
5	<p>To flush out fluids that contain unwanted material, refill the system and repeat steps 3 and 4.</p> <p><b>Note:</b> To prevent contamination use only one type of hydraulic fluid in the instrument.</p>

## 2.4 CALIBRATOR OPERATIONS

### 2.4.1 Basic Calibrator Operation

1. Select:

DASHBOARD >>  CALIBRATOR

2. Select the channel by performing the following tasks.
  - Swipe to the TASK MENU by swiping the display from right to left.

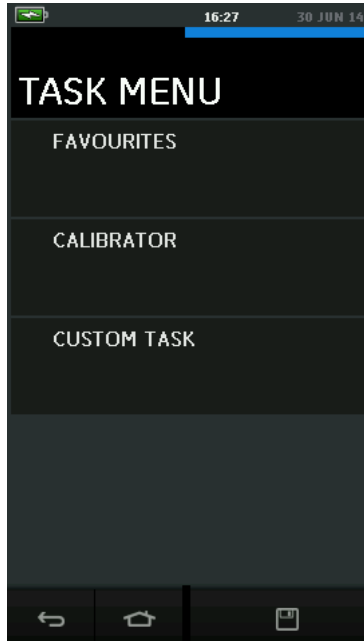



Figure 2-8 Task Menu

#### a. Saving Tasks

At any point within the TASK MENU the currently active tasks can be saved to FAVOURITES by selecting Save  Task.

**Note:** *Saved Function is what is currently active in the calibrator window. It is NOT a selected Task – refer to COPY TASK to copy selected Task to the favourites*

**b. Calibrator**

- I. Select CALIBRATOR from the TASK MENU.  
This will allow the user to select from commonly used combinations of functions.

**Figure 2-9 Calibrator**

- II. Select the required function by touching either the appropriate text or diagram. The DPI612 will set the functions and return to the main Calibrator screen.



**Figure 2-10 Calibrator with selected option**

- III. Functions can be copied to FAVOURITES by selecting as shown in *Figure 2-10* and selecting Copy Task .

If the required task is not available as a Default, a new task should be created using CUSTOM TASK.

#### c. Favourites

- I. Selecting FAVOURITES from the TASK MENU allows selection of all SAVED and COPIED tasks.



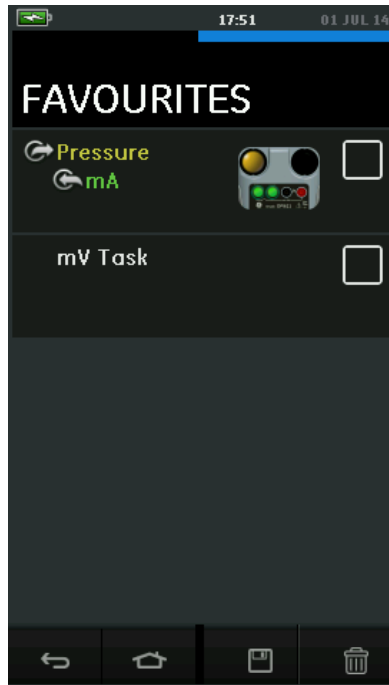



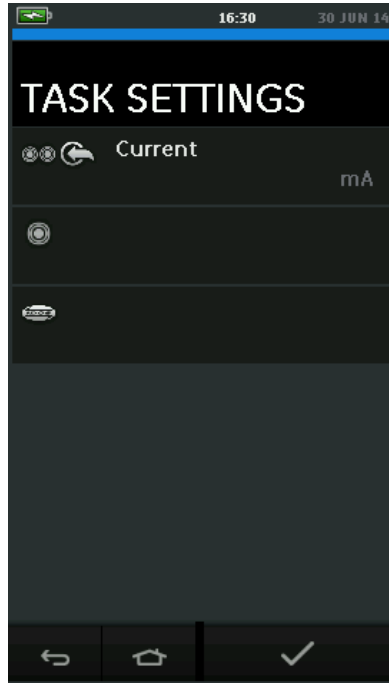

**Figure 2-11 Favourites**

- II. Select the required function by touching either the appropriate text or diagram. The DPI612 will set the functions and return to the main calibrator screen.
  - III. Task can be deleted by selecting DELETE .
- d. Custom Task**
- I. Select the CUSTOM TASK option from **TASK MENU**. This will allow you to set up the Electrical, Pressure and USB (IDOS) channels.







**Figure 2-12 Task Settings Menu**

- II. Select   to enter the CHANNEL SETTINGS menu.
  -  is used for pressure measurements. (See Section 2.5)
  -  IDOS is used for external IDOS sensors. (See Section 2.6)



**Figure 2-13 Channel Settings Menu**

III. Setup a channel for measurement

- DIRECTION selects  Source or  measure for the selected function.
- FUNCTION selects the function required. (E.g.: Current or Voltage). For more options, scroll down the menu by swiping the display from bottom to top.
- UNITS selects the type of unit required, (E.g.: Volts, Amps), please note that there may only be 1 type of unit available in particular Functions.
- UTILITY selects the required utility (*See Section 2.4.2 for details*).
- CAPTION allows the user to change the caption, if required.
- CAPTION RESET allows the user to reset the caption.
- Once all settings have been selected, press the  button at the bottom of the screen to return to the TASK SETTINGS screen.
- Please note for the settings to be set the user must also press the  button in the TASK SETTINGS menu.
- Repeat the above if another channel is required.

## 2.4.2 Set the Function Utility Options

For each function only one utility may be active. Not all source and measure functions have associated utilities. For all options, the  button resets the additional readings.

### a. Max/Min. Avg

This utility is only available with measure functions.

The additional values displayed show the minimum, maximum, and average values of the input signal.



Figure 2-14 Max/Min Example

### b. Switch Test

This utility is available with pressure functions.

The additional values displayed show signal values (measure or source) when the instrument detects a switch opening and closing.

The difference between the two values is displayed as hysteresis value for the switch. This utility can be used with Ramp Automation, where the rising signal causes the switch to change state and the falling signal causes the switch to resume its' original state.



**Figure 2-15 Switch Test Example**

### c. Relief Valve

This utility is only available with measure functions.

This utility tests circuits or mechanisms that have a cut-out response when an input reaches a defined threshold value. The utility allows the user to select a mode of operation which can be rising or falling. The utility displays additional values that represent the maximum and minimum values achieved by the input signal.



Figure 2-16 Relief Valve Example

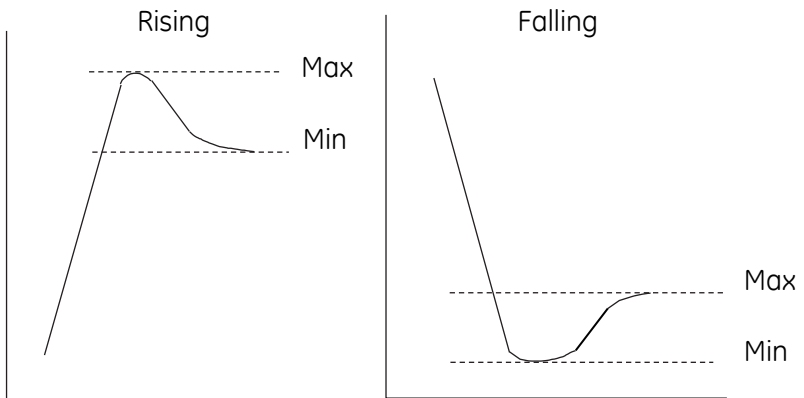

Figure 2-17 Relief Valve Utility

### 2.4.3 Measurement Display Options

There are 2 display views in the CALIBRATOR screen when multiple channels are in use:

- *Figure 2-18* displays a reduced view of all the selected channels.



**Figure 2-18 Calibration Window – Reduced View**

- *Figure 2-19* displays an expanded view of the selected channel and minimizes the remaining channels.

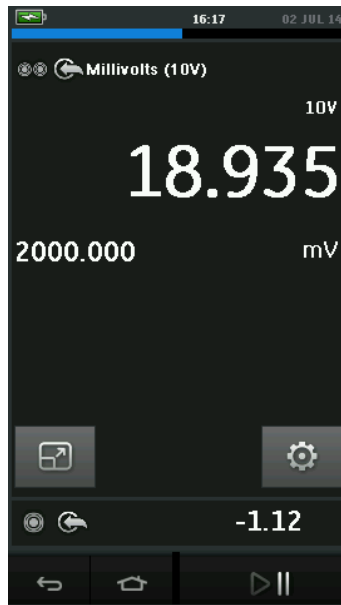

**Figure 2-19 Calibration Window - Expanded View**

The display options can be changed by pressing the channel the user wants to display in expanded view.

Selecting  displays all channels in the reduced view.

#### 2.4.4 Example Procedures

##### a. Example Procedure: Measure or Source Current with internal loop power

- *Figure 2-20 shows CH1 set-up to measure or source a current with internal loop power.  
Note: Loop drive is provided by connecting to the 2 red terminals on the front of the DPI612 and enabling Current (24V) as the electrical function.*



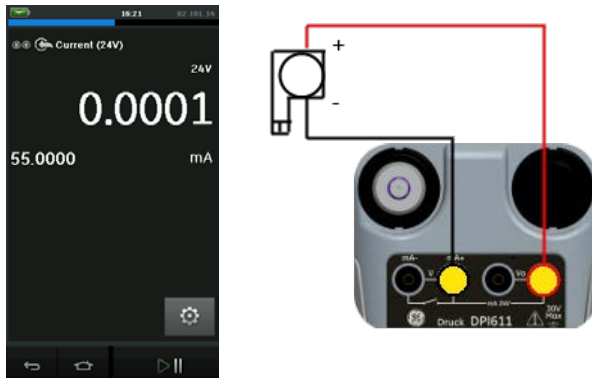

Figure 2-20 Measure current on CH1. Range  $\pm 55$  mA

1. Set the applicable software options.
2. Complete the electrical connections and continue with the measure or source operation.
3. Source only (Automation). Set the applicable output value.

#### b. Example Procedure: Measure Voltage

- *Figure 2-21* shows CH1 set-up to measure a DC voltage ( $\pm 30$  V) or DC mV ( $\pm 2000$  mV).

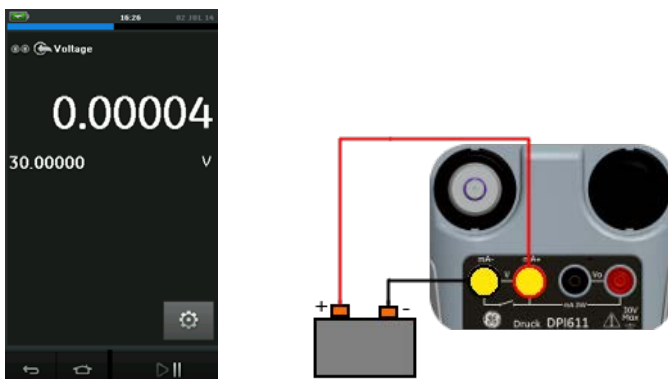
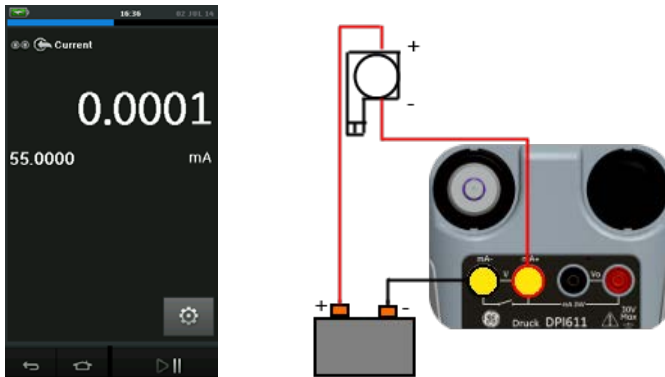

Figure 2-21 Measure DC Volts or DC mV on CH1.

1. Set the applicable software options.
2. Complete the electrical connections and continue with the measure operation.

**c. Example Procedure: Measure or Source Current with External Loop drive**

- *Figure 2-22 and Figure 2-23 show how to set-up to measure ( $\pm 55\text{mA}$ ) or source (0 to 24mA) a current with external loop power.*



**Figure 2-22 Measure current with external loop power (Range:  $\pm 55\text{mA}$ )**

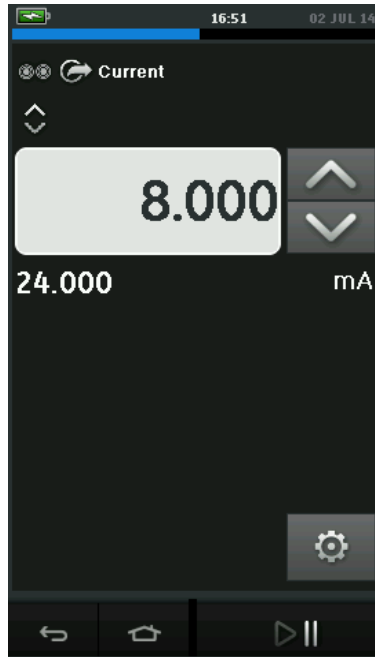

**Figure 2-23 Source current with external loop power. (Range: 0 to 24 mA)**

1. Set the applicable software options.
2. Complete the electrical connections and continue with the measure or source operation.
3. Source only (Automation): Set the applicable output value.

#### **d. Example Procedure: Switch Test**

Switch Test is only valid when a Pressure Function is selected.

##### **Switch operation**

When setting the Switch Test, the software automatically sets the electrical channel to the switch test function.

*Note: If there is an electrical function already selected it will automatically be disabled. The display will show a screen message.*

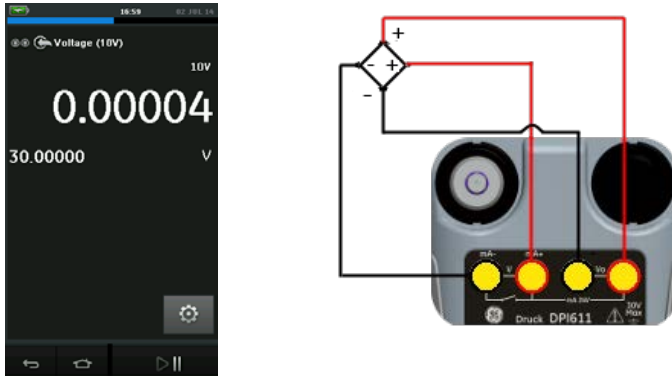

Figure 2-24 Switch Test

e. **Example Procedure: Measure Voltage with Internal Voltage Source**

Figure 2-25 shows CH1 set-up to measure a DC voltage ( $\pm 30$  V) or DC mV ( $\pm 2000$  mV) with Internal Voltage Source (e.g. for use with Resistive bridge).

**Note:** Internal Voltage is provided by connecting to the  $V_o$  terminals on the front of the DPI612 and enabling Voltage (10V) or Millivolts (10V) as the electrical function.



**Figure 2-25 Measure DC Volts (10V) or DC mV (10V) on CH1**

1. Set the applicable software options.
2. Complete the electrical connections and continue with the measure operation.

## 2.5 PRESSURE CALIBRATION

PRESSURE TASKS are available in the TASK MENU. See *Section 2.4.1 Basic Calibrator Operation* for details.

Select the required function by touching either the appropriate text or diagram. The DPI612 will set the functions and return to the CALIBRATOR screen.

Pressure Functions can also be selected through the CUSTOM TASK function. See *Section 2.4.1* for details.

If required, change the Units or the function. If necessary, set a Utility for the function:

- Max/Min/Avg
- Switch Test
- Relief valve
- Leak Test

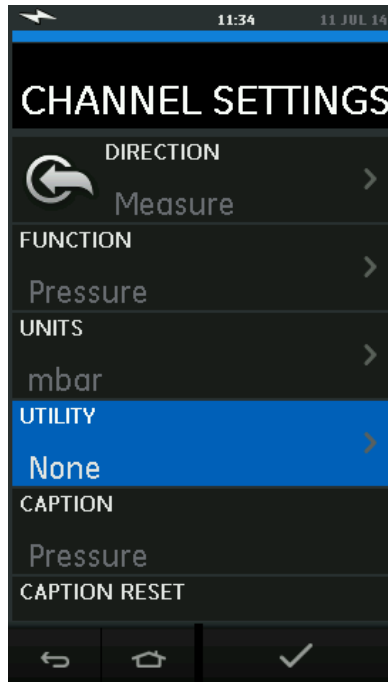

**Figure 2-26 Channel Settings**

**Note:** *UNITS and UTILITIES are accessed through selecting the function through CUSTOM TASK.*

### 2.5.1 Set up a Leak Test

 This utility is only available in Pressure Measurement modes.

This utility provides a test to calculate the leak of a system.



**Figure 2-27 Leak Test Example**

To configure leak test:

1. Set the Utility to Leak Test.  
Select:

 SETTINGS >> LEAK TEST

2. Set the following periods  
**WAIT TIME:**  
The time before the test starts in hours:minutes:seconds (hh:mm:ss).  
**TEST TIME:**  
The period of the leak test in hours:minutes:seconds (hh:mm:ss)

3. Use  to start the Leak Test

4. Use  to stop the Leak Test.

## 2.5.2 Set the Pressure Module to Zero

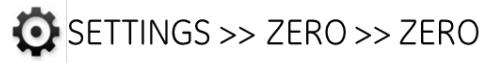

Use this option to write a new zero pressure value to the pressure module in use. The sensor adjustment is permitted if it obeys the condition that follows:

- Adjustment  $\leq 10\%$  FS positive pressure value (for the Sensor).  
**Note:** To make a temporary adjustment for zero, use the Tare function.

## 2.5.3 Error Indications

**Under range:** The display shows this symbol for this condition:

<<<<<

Reading < 110% Negative Full Scale (Pressure)

Reading < 102% Negative Full Scale (Electrical)

**Over range:** The display shows this symbol for this condition:

>>>>>

Reading > 110% Positive Full Scale (Pressure)

Reading > 102% Positive Full Scale (Electrical)

If the display shows <<<< (under range) or >>>> (over range):

- Make sure that the range is correct.
- Make sure that all the related equipment and connections are serviceable.

## 2.6 MEASURE PRESSURE: IDOS Option

Optional item, An IDOS Universal Pressure Module (UPM) uses Intelligent Digital Output Sensor (IDOS) technology to measure the applied pressure and supply the data to an IDOS instrument. Before using an IDOS module, (Ref: User Manual: K0378, Druck IDOS UPM).

**Note:** To attach an IDOS module to the Druck DPI612 use an IO620-IDOS-USB adaptor.



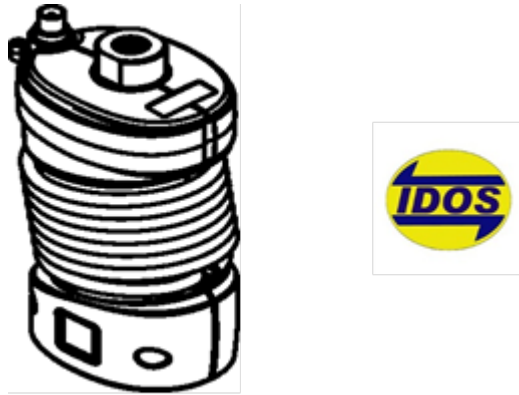



Figure 2-28 IDOS Module

### 2.6.1 IDOS Option Assembly Instructions

Table 2-6

Step	Procedure
1	Attach one end of the adaptor IO620-IDOS-USB to the IDOS module
2	Push the Type A end of USB Cable into the USB socket on the instrument and the type B end into the adaptor (IO620-IDOS-USB)
3	Set the instrument power on
	When this symbol flashes at the top of the display, it shows there is communication between the IDOS module and the calibrator

### 2.6.2 IDOS Function Procedures

The procedures for an IDOS module are the same as for the internal pressure sensor.

Enable the IDOS module from the TASK menu:

- IDOS function (Measure or Differential)
- If necessary, change the Units for the function
- If necessary, set a Utility for the function:
  - I. Max/Min/Avg
  - II. Switch Test

III. Leak Test

IV. Relief Valve

The Settings menu for the IDOS module contains the following options.

- Units.
- Process (Tare, Alarm, Filter, Flow, Scaling).
- Zero. The procedure is the same for an IDOS module or the internal pressure sensor. Zero the gauge sensor before use.
- Resolution. Select the number of digits to be displayed.

### 3 DATA LOGGING OPERATION

Select the  DATA LOGGING option on the Dashboard. The Data Logging function records instrument readings so they can be reviewed or analyzed.

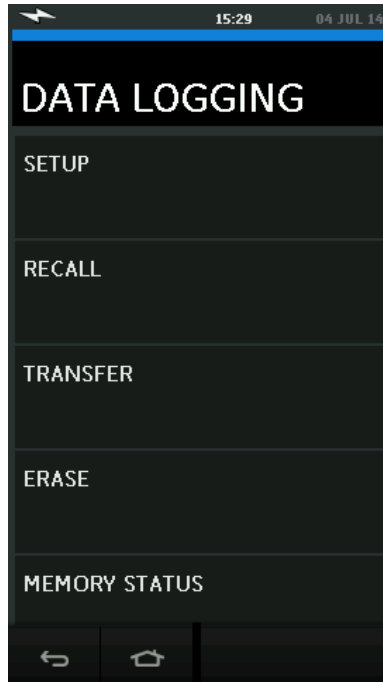

**Figure 3-1 Data Logging**

The data file can be reviewed by using the following:

- RECALL

The data file can be processed externally by using the following:

- TRANSFER
  - Transfer to a USB Flash Drive
  - Transfer to a Computer via serial port

This chapter describes how to use the Data Logging function to log data to a file.

In Data Logging mode the display data from all active channels is stored at each data point.

The data can be stored:

- Periodically
- Key press

The data is stored in the internal memory or on a USB Flash Drive connected to the Unit until the Data Logging is stopped.

### 3.1 SET-UP

Before starting, set all channels to the correct functions. (See *Chapter 2*). To access the Data logging function do the following:

DASHBOARD >>  DATA LOGGING >> SETUP

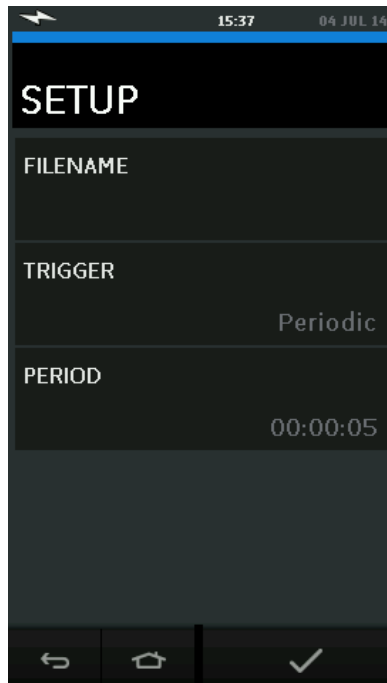

Figure 3-2 Data logging Setup

- **FILENAME**  
Enter the filename (10 characters maximum).

- **TRIGGER**

Select one of the following:

- a. Key Press (logs one data point each time the button is pressed).
- b. Periodic (logs one data point at a set time interval).

- **PERIOD**

This option is used to set the time interval for periodic data logging.

To start Data Logging Mode:

1. Select appropriate options and enter filename for Data Log file.  
**Note:** *When entering filename it is first necessary to select destination (INTERNAL or USB FLASH DRIVE)*
2. Select the  button.

## 3.2 OPERATION

In periodic mode, to begin data logging tap 'Start logging'  button.

In Key press mode, a data point is taken every time the user taps the log button .



To stop Data Logging select .

The data logging indicator  flashes to indicate whenever a reading is logged.

### 3.3 FILE REVIEW

## DASHBOARD >> DATA LOGGING >> RECALL

To view a data file point by point do the following:

1. Tap the Filename button to display the list of data files.
2. Select the file to be displayed.
3. Tap  to see the data display.
4. To step the display one data point, tap the Next Log button .  
**Note:** *The data point number sequence is displayed in the top right-hand corner (e.g. 4 of 100).*
5. To go back one data point, press the Previous Log button .
6. Exit the screen.

### 3.4 FILE MANAGEMENT

The data log file management options are as follows:

- **TRANSFER**  
Upload data log files to another computer.
- **ERASE**  
Delete data log files.
- **MEMORY STATUS**  
Displays amount of free memory.

#### 3.4.1 Transfer

Data may be transferred as follows:

- **USB Flash Drive:** Selected files are written in the root folder of the USB Flash Drive.
- **USB Serial Port:** Transfers data as a text file to a computer. A communications program can be used to receive the data (e.g. Microsoft® Hyper Terminal). The serial set-up is as follows:

Baud rate: 19,200 bits/sec  
Data bits: 8  
Parity: none  
Stop bits: 1

### 3.4.2 Erase

The Erase options are as follows:

- ERASE ONE FILE: Select file and tap tick bottom right on the screen to erase.
- CLEAR INTERNAL: Clears all internal files.

### 3.4.3 Memory Status

The MEMORY STATUS button will show the amount of available memory in the areas that follow:

- Internal
- USB Flash Drive (if fitted)

## 3.5 DATA FORMAT

The data files are produced in a Comma Separated Variable (csv) format (*See Figure 3-3*). This allows the data to be imported into a spreadsheet (e.g. Microsoft® Excel). The first section of the data file contains the following:

FILENAME - The data file name

COLUMNS - Information for internal use

START - Data log start time

VERSION - Data format version

CHANNEL - The function setting of each active channel

The second section of the data file contains the following:

Individual headings

Data point data

```
FILENAME,P080821A
COLUMNS,3,9
START,21 Aug 2008, 21:38:59
CHANNEL 001, Current (24V),In,mA,55
CHANNEL 005, HART,In,,0
DATA,START
ID,Date,Time,Main Reading,Secondary Reading,
0,21 Aug 2008, 21:39:14,8.7525,24V,4,0,False
1,21 Aug 2008, 21:39:29,8.5711,24V,4,0,False
2,21 Aug 2008, 21:39:44,8.4080,24V,4,0,False
3,21 Aug 2008, 21:39:59,8.2475,24V,4,0,False
4,21 Aug 2008, 21:40:14,8.0733,24V,4,0,False
5,21 Aug 2008, 21:40:29,7.9288,24V,4,0,False
```

**Figure 3-3 Example .csv Data log File**



## 4 DOCUMENTATION

This chapter describes the Documenting functions available with the Druck DPI612 calibrator as follows:

- ANALYSIS
- RUN PROCEDURE

### 4.1 ANALYSIS

The Analysis function takes readings from two or more DPI612 channels to calibrate the transfer characteristic of the device being tested. One channel is the Reference channel and is used as follows:

- It provides a measure of the input signal to the device.
- If the device is a pressure transmitter the Reference channel would be Pressure, measuring the input pressure to the device.



The other channel is the Input channel and is used as follows:

- Measures the output signal from the device
- If calibrating a process transmitter it could be the electrical channel in Current Measure mode.

Any active channel that is not defined as Reference is Input by default.

There must be one Reference channel and at least one Input channel defined for the Analysis function set-up to be correct.

At each value the Analysis function calculates the difference of each Input channel to the ideal transfer characteristic and compares this to a tolerance limit.

- The deviation is shown in %Span or %Rdg
- The tolerance test result is shown a Pass  or  Fail icon.

## 4.2 SET-UP

1. Set the Druck DPI612 channels in the Calibrator function. (See *Section 2.2.1*).
2. Connect the calibrator to the device under test.
3. Enter the Documenting function.

DASHBOARD >>  DOCUMENTING

4. Tap the ANALYSIS button.

### 4.2.1 Define the Reference Channel

1. Tap the channel button that is to be used as the Reference channel for the analysis.

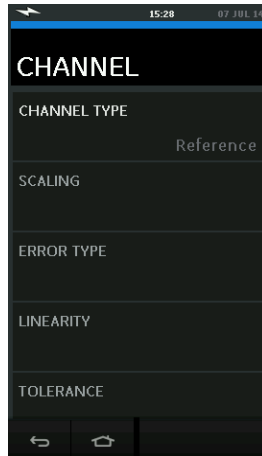
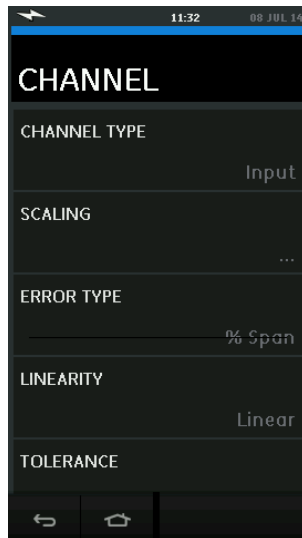

**Figure 4-1 Select Reference Channel**

2. Set the channel type to Reference.
3. All other channel settings for that channel are cancelled. All other active channels are set to Input.

### 4.2.2 Define each Input Channel

Tap each Input channel button to set the Input options.



**Figure 4-2 Select Input Options**

- SCALING** The scaling values are two pairs of values that define the ideal transfer characteristic:  
The maximum and minimum Reference signal values (Reference High and Reference Low) and the corresponding Input signal values (Input High and Input Low).
- ERROR TYPE -** Selects how the deviation from the ideal transfer characteristic is to be displayed. This can be one of the following:  
**% Span** - a percentage of the Input signal span.  
**% Rdg** - a percentage of the Input signal reading.
- LINEARITY -** The transfer characteristic from Reference to Input signal. This can be one of the following:  
**Linear** - a proportional response.  
**Square Root** - often found in flow sensors.
- TOLERANCE -** The test limits for the deviation from the transfer characteristic.



### 4.3 ANALYSIS FUNCTION

Set Input channel parameters (See *Section 4.2*), and return to CHANNEL SETUP screen.

Select the Start button .

The Analysis window displays the following:

- The deviation of each Input channel from the ideal transfer characteristic.
- A tolerance limit test icon

Pass		(within tolerance test limit)
Fail		(outside tolerance test limit)

To check the full range of the device do the following:

1. Step the Reference signal value through its range.
2. Check the Analysis window at each step.
3. If the Reference is sourced from the calibrator, move to the channel window to change the Reference value.
4. Return to the Analysis window.
5. When the analysis is complete exit the window by selecting exit .

### 4.4 RUN PROCEDURE

The purpose of the Run procedure is to do calibration procedures which have been downloaded from 4 Sight software. The 4 Sight calibration procedures contain all the values to calibrate a device under test (test points, ramp time).



The same calibration procedure can be used for all the applicable devices under test. To use the Run Procedure function, the following items are required:

- A copy of the 4 Sight Calibration Software.
- Standard USB lead (as supplied).

- A Druck DPI612 calibrator device driver available as a download from the website [www.gemeasurement.com](http://www.gemeasurement.com).

#### 4.4.1 Sequence to Upload and Download file

**Table 4-1**

Step	Procedure
1	Connect the USB cable (See <i>Section 1.10, Accessories</i> ) to the Druck DPI612 calibrator.
2	Connect the lead to the USB port on the computer that has the calibrator manager installed.
3	Use 4 Sight to set-up the procedure and create a work order for the device. The procedure includes the parameters for the calibration, the number of test points, the relationship and pass/fail tolerance.
4	Use the Download button in calibrator manager to Download the file to the Druck DPI612 calibrator. A communications symbol will be displayed at the bottom of the screen.
5	Select: DASHBOARD >> DOCUMENTING >> RUN PROCEDURE
6	In the Results window, select the filename specified in calibrator manager.
7	Enter the User ID and the DUT Serial Number.
8	Tap on the Start button  . The procedure sets up the necessary Channel options e.g. mA and Volts.
9	Use the Take Reading button at each point specified by the procedure. A prompt show for each point.
10	When all the readings are complete, tap on the Exit Button  . Look at the results on the display (As found/As Left).
11	To complete the process, use the calibrator manager to Upload the file back into the 4 Sight database.

## 5 CALIBRATION

### 5.1 GENERAL

The instrument is supplied by the manufacturer, complete with calibration certificate(s). A calibration period of 12 months is recommended. The actual calibration interval depends on instrument usage and the total measurement uncertainty acceptable for the specified application.

The DPI612 is a very precise measuring instrument and the test equipment and conditions of test must be suitable for the type of work. The calibration check and calibration adjustment should be carried out in a controlled environment by a calibration technician.

**Note:** *A calibration technician must have the necessary technical knowledge, documentation, special test equipment and tools to carry out the calibration work on this equipment.*

**Note:** *GE Measurement and Control can provide a calibration service that is traceable to international standards.*

**Note:** *GE Measurement and Control recommend returning the instrument to the manufacturer or an approved service agent for calibration. If using an alternative calibration facility, check that it uses the standards that follow.*

### 5.2 CALIBRATION CHECK

At the chosen calibration interval, the instrument readings should be compared with a known pressure standard.

The recommended method starts at 0, increasing in 20% steps to 100% full-scale and then decreasing in 20% steps to 0.

Note any deviations between the instrument and the pressure standard and consider traceability (accuracy to a National Standard).

If, after a calibration check, the results exceed the tolerance in the specification (or other suitable performance standard), carry out a calibration adjustment.

### 5.3 CALIBRATION ADJUSTMENTS

If the instrument is operating correctly, only zero and full-scale calibration will vary. Any excessive non-linearity or temperature effects indicate a fault. The instrument should be returned to a qualified service agent.

### 5.4 BEFORE STARTING

Use only original parts supplied by the manufacturer. To do an accurate calibration, use the following:

- Calibration equipment specified in *Table 5-1*.
- Stable temperature environment:  $21 \pm 1^{\circ}\text{C}$  ( $70 \pm 2^{\circ}\text{F}$ ).

Before starting a calibration procedure, it is recommended leaving the equipment in the calibration environment for a minimum of two hours.

**Table 5-1**

Function	Calibration equipment (ppm = parts per million)
Current	Current (mA) calibrator. Accuracy - Current measure/source, <i>See Table 5-2 and Table 5-3.</i>
Voltage	Volts calibrator. Accuracy - Voltage measure/source, <i>See Table 5-5 or Table 5-6.</i>
Millivolts	mV calibrator. Accuracy - Millivolts measure/source, <i>See Table 5-4 .</i>
Pressure (P1)	All Ranges total uncertainty of 0.025% reading or better.
IDOS	UPM only. Refer to the user manual for the IDOS UPM.

Before starting the calibration, check the time and date on the instrument are correct.

To do a calibration on a measure or source function, use the advanced menu option.

Select:

DASHBOARD >>  SETTINGS  
>> ADVANCED

Enter the calibration PIN: 4321

Select the  button.

Select:           PERFORM CALIBRATION

Then select a function and start the calibration:

1. Select channel
2. Select function
3. Select range (if applicable)
4. Follow on-screen instructions

When the calibration is complete, set the next calibration date.

## 5.5 PROCEDURES: CURRENT (measure)

Do the procedure as follows:

1. Connect the applicable calibration equipment (*See Table 5-1*)
2. Let the equipment get to a stable temperature (minimum: 5 minutes since the last power on).
3. Use the calibration menu (*See Section 5.4*) to do a three-point calibration (-FS, Zero and +FS) for each range: 20 mA and 55 mA.
4. Check the calibration is correct.
  - Select the applicable Current (measure) function.



- Apply the values that follow:  
mA: -55, -25, -20, -10, -5, 0 (open circuit)  
mA: 0, 5, 10, 20, 25, 55.
- Check the error is in the specified limits (See *Table 5-2*).

**Table 5-2 Current (measure) error limits**

Applied mA	Calibrator uncertainty (mA)	Permitted DPI612 error (mA)
±55	0.0030	0.0057
±25	0.0025	0.0043
±20	0.00063	0.0022
±10	0.00036	0.0016
±5	0.00025	0.0013
0 (open circuit)	0.0002	0.0010

## 5.6 PROCEDURES: CURRENT (source)

When recalibrating measure and source functions for this range, the measure function must be adjusted before the source function.

Do the procedure as follows:

1. Connect the applicable calibration equipment (See *Table 5-1*):
  - CH1 (24 mA range): (See *Table 5-3*).
2. Let the equipment get to a stable temperature (minimum: 5 minutes since the last power on).
3. Use the calibration menu (See *Section 5.4*) to do a two-point calibration (0.2 mA and FS):
  - CH1: 24 mA.
4. Check the calibration is correct:
  - Select the applicable Current (source) function
  - Apply the values that follow:  
mA: 0.2, 6, 12, 18, 24
  - Check the error is within limits (See *Table 5-3*)

**Table 5-3 Current (source) error limits**

Applied mA	Calibrator uncertainty (mA)	Permitted DPI612 error (mA)
0.2	0.00008	0.0013
6	0.00023	0.0017
12	0.00044	0.0020
18	0.0065	0.0024
24	0.0012	0.0028

## 5.7 PROCEDURES: DC mV/Volts (measure)

Do the procedure as follows:

1. Connect the applicable calibration equipment (See *Table 5-1*).
2. Let the equipment get to a stable temperature (minimum: 5 minutes since the last power on).
3. Use the calibration menu (See *Section 5.4*) to do a three-point calibration.  
(-FS, Zero and +FS) for the applicable set of ranges:

mV (measure) ranges

200 mV

2000 mV

Volts (measure) ranges

20 V

30 V

4. Check the calibration is correct:
  - Select the applicable Millivolts or Voltage (measure) function.
  - Apply the input values that are applicable to the Calibration:

mV: -2000, -1000, -200, -100, 0 (short circuit)

mV: 0, 100, 200, 1000, 2000

Volts (V): -30, -21, -20, -10, -5, 0 (short circuit)

Volts (V): 0, 5, 10, 20, 21, 30.

- Check that the error is within limits (See *Table 5-4* and *Table 5-5*).

**Table 5-4 Millivolts (measure) error limits**

Applied mV	Calibrator uncertainty (mV)	Permitted DPI612 error (mV)
±2000	0.051	0.1280
±1000	0.040	0.0940
±200	0.051	0.0148
±100	0.0040	0.0110
0 (short circuit)	0.0036	0.0070

**Table 5-5 Voltage (measure) error limits**

Applied V	Calibrator uncertainty (V)	Permitted DPI612 error (V)
±30	0.00052	0.00180
±21	0.00040	0.00154
±20	0.00031	0.00118
±10	0.00016	0.00089
±5	0.00008	0.00075
0	0.000024	0.00060

## 5.8 PROCEDURES: DC Volts (source)

Do the procedure as follows:

1. Connect the applicable calibration equipment (See *Table 5-1*).
2. Let the equipment get to a stable temperature (minimum: 5 minutes since the last power on).
3. Use the calibration menu (See *Section 5.4*) to do a two-point calibration for the applicable range:

### Volts (source) range

10 V

24 V

4. Check the calibration is correct:
  - Select the applicable Voltage (10V) or Current (24V) (measure) function (*See Section 5.7*).  
10V  
24V
  - Check the error is within limits (*See Table 5-6*).

**Table 5-6 Voltage (source) error limits**

Source V	Calibrator uncertainty (V)	Permitted DPI612 error (V)
10	0.0001	0.0015
24	0.0004	0.0036

## 5.9 PROCEDURES: PRESSURE INDICATOR

Do the procedure as follows:

1. Connect the instrument to the pressure standard.
2. Let the equipment get to a stable temperature (minimum: 60 minutes since the last power on).
3. Use the calibration menu (*See Section 5.4*) to do a two-point calibration.
  - Zero and +FS for gauge sensors.
4. Check the calibration is correct:
  - Select the applicable pressure function.
  - Apply the following pressure values.  
  
0, 20, 40, 60, 80, 100, 80, 60, 40, 20 (%FS).
  - Apply the following pressure values.  
  
-200, -400, -600, -800, -600, -400, -200, 0 mbar.
  - Check the error is within limits

From the datasheet use the values in the Accuracy column.

## 5.10 PROCEDURES: IDOS UPM

*(Refer: User Manual IDOS UPM).*

When the calibration is complete, the instrument automatically sets a new calibration date in the UPM.

## 6 ACCESSORY INSTRUCTIONS

### 6.1 Dirt Moisture Trap 20 bar (P/N IO620-IDT621)



#### 6.1.1 Specification:

**Maximum working pressure:** 20bar / 300psi pneumatic.

**Orientation:** Use only in the vertical position.

#### 6.1.2 Pressure connections:

**Lower:** To DPI612 Test Port.

**Upper:** AMC quick-connect ( for use with all DPI612 adaptor sets )

**Materials of Construction:** 316L and 303 Stainless steels, Acrylic, Nitrile seals, P.T.F.E.

#### 6.1.3 Operation:

##### **Important Note:**

This device is designed for use on the DPI 612 pFlex 20 bar pneumatic pressure calibrator.

1. Fit the Dirt Moisture Trap to the Test Station of the DPI 612 pFlex.
2. If moisture or particles are seen within the transparent chamber during use, dismantle and clean the trap. ( see below).

### 6.1.4 Cleaning:

1. Unscrew the top section, releasing the transparent chamber.
2. Clean the components



**DO NOT USE SOLVENTS - this will damage the acrylic chamber and seals.**

3. Wipe clean with a soft cloth or tissue paper.
4. Re-assemble ensuring that all seals are in the correct location.

## 6.2 Dirt Moisture Trap 100 bar (P/N IO620-IDT622)



### 6.2.1 Specification:

**Maximum working pressure:** 100bar / 1500psi pneumatic.

#### **Important Notes:**

This device is designed for use on the DPI612 PFlexPro100 bar pneumatic pressure calibrator.

It should be removed from the calibrator during transit.

It should be inspected internally for dirt or moisture before and after use.

**Orientation:** Use only in the vertical position.

### 6.2.2 Pressure connections:

**Lower:** To DPI 612 pFlexPro test port.

**Upper:** AMC quick-connect (for use with all DPI612 adaptor sets)

Materials of Construction: 316L and 303 Stainless steels, 6082 Aluminium, Nitrile seals, P.T.F.E.

### 6.2.3 Operation:

1. Check for moisture or dirt particles within the aluminium chamber before and after use.  
If found, dismantle and clean as instruction below.
2. Fit the Dirt Trap to the Test Station of the DPI 612 pFlexPro pressure calibrator.  
Hand-tight only – no spanners / wrenches are required.
3. Fit AMC adaptor to suit item under test. ( hand-tight only)



### 6.2.4 Cleaning:

1. Unscrew the top section, releasing the chamber.
2. Clean the components



**DO NOT USE SOLVENTS - this will damage the seals.**

3. Wipe clean with a soft cloth or tissue paper.
4. Re-assemble by screwing the top section (hand-tight) onto the base and chamber ensuring that the two o-ring seals are correctly located.

## 7 GENERAL SPECIFICATION

For a full specification of the Druck DPI612 calibrator and its related accessories refer to the relevant product datasheet.

The DPI 612 is suitable for indoor use with the following environmental requirements. It is permitted to use the DPI 612 outdoors as a portable instrument if the environmental requirements are met.

**Table 7-1**

Display	Size: 110 mm (4.3in) diagonal. 480 x 272 pixels. LCD: Color display with touch-screen
Languages	English (default), Chinese, Dutch, French, German, Italian, Japanese, Korean, Portuguese, Russian, Spanish
Operating temperature	-10°C to 50°C (14°F to 122°F), 0°C to 40°C (32°F to 104°F) when powered from optional mains adaptor IO620-PSU
Storage temperature	-20°C to 70°C (-4°F to 158°F)
Ingress Protection	IP54. Protected against dust and splashing water from any direction
Humidity	0 to 90% RH none condensing. To Def Stan 66-31, 8.6 cat III
Shock / Vibration	BS EN 61010-1:2010 / MIL-PRF-28800F CLASS 2
Altitude	Up to 2000m
EMC	BS EN 61326-1:2013
Electrical safety	BS EN 61010-1:2010
Pressure safety	Pressure Equipment Directive - Class: Sound Engineering Practice (SEP)
Enclosure materials	Polycarbonate, polyamide, polypropylene, acrylic, cotton
Approved	CE Marked
Size (L:W:H)	DPI612-PFX = 350 x170 x 145 mm (13.7 x 6.7 x 5.7 in ) DPI612-PFP = 350 x170 x 160 mm (13.7 x 6.7 x 6.3 in ) DPI612-HFP = 350 x170 x 170 mm (13.7 x 6.7 x 6.7in )

Weight	DPI612-PFX = 3.4kg (7.5 lb) DPI612-PFP = 4.1kg (9.0 lb) DPI612-HFP= 4.7kg (10.4 lb)
Power supply	8 x AA alkaline batteries / Li-on rechargeable battery pack. Optional mains adaptor P/N IO620-PSU 100-260V +/- 10%, 50 / 60Hz AC, Output DC V=5A, 1.6A
Battery life	12 to 26 hours depending on functions
Connectivity	USB type A, USB type mini B

**Note 1:** *The DPI612 has been assessed to the European IEC60529 standard as having an ingress protection rating of IP54, but this is for reliability purposes and not for safety reasons.*

**Note 2:** *The case of the DPI612 is not suitable for prolonged exposure to UV.*

**Note 3:** *The DPI612 is not suitable for permanent installation in an outdoor environment.*

## 8 TROUBLESHOOTING

### 8.1 DPI 612 pFlex

<b>Fault Symptom</b>	<b>Possible Cause</b>	<b>Check</b>
Unit will not generate pressure with integral pump.	<p>Mode selector incorrectly set.</p> <p>Sensor not fitted to sensor port.</p> <p>Output port not connected.</p> <p>Release Valve not closed.</p>	<p>Mode selector is in "+" position.</p> <p>Sensor (or blank IO620-BLANK) fitted to sensor port.</p> <p>Output port connected to DUT or fitted with suitable blanking plug.</p> <p>Ensure Release valve is firmly closed.</p>
Unit will not generate vacuum with integral pump.	<p>Mode selector incorrectly set.</p> <p>Sensor not fitted to sensor port.</p> <p>Output port not connected.</p> <p>Release Valve not closed.</p>	<p>Mode selector is in "-" position.</p> <p>Sensor (or blank IO620-BLANK) fitted to sensor port.</p> <p>Output port connected to DUT or fitted with suitable blanking plug.</p> <p>Ensure Release valve is firmly closed.</p>
Excessive leak rate, (pressure or vacuum).	<p>Incorrectly connected system (DPI612 to DUT).</p> <p>DUT has leak.</p> <p>Worn pressure seal on outlet port ('O' ring &amp; backup ring).</p> <p>Release Valve not closed.</p>	<p>Check connecting accessories are fitted in accordance with instructions &amp; correct sealing method is in use.</p> <p>Isolate DUT from DPI612 &amp; check for leaks in DPI612 &amp; DUT independently.</p> <p>Inspect seal on pressure port for signs of wear &amp; replace as necessary.</p> <p>Ensure Release valve is firmly closed.</p>
Unit will not reach desired pressure.	<p>PRV (if fitted) operating at lower pressure than required.</p>	<p>Check PRV range (if fitted) &amp; adjust PRV if range is suitable. Fit correct range PRV. Re-fit PRV blanking plug supplied with unit.</p>

## 8.2 DPI 612 pFlexPro

Fault Symptom	Possible Cause	Check
Unit will not generate pressure with integral pump.	<p>Mode selector incorrectly set.</p> <p>Sensor not fitted to sensor port.</p> <p>Output port not connected.</p> <p>Release Valve not closed.</p>	<p>Mode selector is in "+" position.</p> <p>Sensor (or blank IO620-BLANK) fitted to sensor port.</p> <p>Output port connected to DUT or fitted with suitable blanking plug.</p> <p>Ensure Release valve is firmly closed.</p>
Unit will not generate vacuum with integral pump.	<p>Mode selector incorrectly set.</p> <p>Sensor not fitted to sensor port.</p> <p>Output port not connected.</p> <p>Release Valve not closed.</p> <p>Refill Valve closed.</p>	<p>Mode selector is in "-" position.</p> <p>Sensor (or blank IO620-BLANK) fitted to sensor port.</p> <p>Output port connected to DUT or fitted with suitable blanking plug.</p> <p>Ensure Release valve is firmly closed.</p> <p>Open Refill valve ( fully counter-clockwise).</p>
Excessive leak rate, (pressure or vacuum).	<p>Incorrectly connected system (DPI612 to DUT).</p> <p>DUT has leak.</p> <p>Worn pressure seal on outlet port ('O' ring &amp; backup ring).</p> <p>Release Valve not closed.</p>	<p>Check connecting accessories are fitted in accordance with instructions &amp; correct sealing method is in use.</p> <p>Isolate DUT from DPI612 &amp; check for leaks in DPI612 &amp; DUT independently.</p> <p>Inspect seal on pressure port for signs of wear &amp; replace as necessary.</p> <p>Ensure Release valve is firmly closed.</p>
Unit will not reach desired pressure.	<p>PRV (if fitted) operating at lower pressure than required.</p>	<p>Check PRV range (if fitted) &amp; adjust PRV if range is suitable. Fit correct range PRV.</p> <p>Re-fit PRV blanking plug supplied with unit.</p>

## 8.3 DPI 612 hFlexPro

Fault Symptom	Possible Cause	Check
Unit will not generate pressure with integral priming pump/hydraulic ram	<p>Insufficient hydraulic fluid in reservoir.</p> <p>System not primed correctly.</p> <p>Output port not connected.</p> <p>Release Valve not closed.</p>	<p>Verify reservoir has sufficient fluid to generate pressure, (at least 75% of capacity).</p> <p>Follow priming instructions to ensure air is removed from the system.</p> <p>Output port connected to DUT or fitted with suitable blanking plug.</p> <p>Ensure Release valve is firmly closed.</p>
Excessive leak rate.	<p>System not primed correctly.</p> <p>Incorrectly connected system (DPI612 to DUT).</p> <p>DUT has leak.</p> <p>Worn pressure seal on outlet port ('O' ring &amp; backup ring).</p> <p>Release Valve not closed.</p>	<p>Follow priming instructions to ensure air is removed from the system.</p> <p>Check connecting accessories are fitted in accordance with instructions &amp; correct sealing method is in use.</p> <p>Isolate DUT from DPI612 &amp; check for leaks in DPI612 &amp; DUT independently.</p> <p>Inspect seal on pressure port for signs of wear &amp; replace as necessary.</p> <p>Ensure Release valve is firmly closed.</p>
Pressure remains trapped in system.	Refill/Release valve closed.	Check Refill valve is open, (minimum 1 turn counter-clockwise), & release valve is open, (minimum 1 turn counter-clockwise).
Unit will not reach desired pressure.	PRV (if fitted) operating at lower pressure than required.	Check PRV range (if fitted) & adjust PRV if range is suitable. Fit correct range PRV. Re-fit PRV blanking plug supplied with unit.

## 8.4 General

Fault Symptom	Possible Cause	Check
Unit will not connect / write to USB Memory Stick	USB flash drives with a capacity of 1GB can take a few seconds to fully connect	Try with smaller capacity USB Drive
Unit will not connect to calibration management software	Communications mode set to storage	From the DASHBOARD select SETTINGS then DEVICES; the USB client port should be set to Communications.
Unit will not Switch On	Faulty / Flat battery	Try Using External Power Supply  Remove Battery and Replace
Unresponsive Unit	Processor Lock-up	Press and hold power switch  Remove Battery / Power and replace



## 9 MANUFACTURER

Druck Limited  
Fir Tree Lane  
Groby  
Leicester  
LE6 0FH  
United Kingdom

Tel: +44 (0)116 231 7100

[www.gemeasurement.com](http://www.gemeasurement.com)